

# VERITY

## PRICE BOOK



FRÍANT

ALL  
WORKSTYLES  
WELCOME

# TABLE OF CONTENTS

## INTRODUCTION

Terms and Conditions	3	Double Sided to Single Sided, End of Run and Inline	15
Standard Fabrics	6	Grommet Locations	16-21
Pattern Direction	7	Power Grommets	22
Standard Finishes	8	Data Port Plate	23
Pull Options	9	How to Specify My-Hite 2 Piece Extended Corner or Rectangular Tops	24
Ordering Verity: Elements	10		
Support Selection	11		
Powering Verity	14		

## ELEMENTS

### STARTER/END ELEMENTS

Starter/End Element, Single-Sided	
Non-Powered	26
Powered	27
Starter/End Element, Double-Sided	
Non-Powered	28
Powered	29
Starter/End Element, 120° 3 Pack	
Non-Powered	30
Powered	31

### EXTENSION ELEMENTS

Extension Element, Single-Sided	
Non-Powered	32
Powered	33
Extension Element, Double-Sided	
Non-Powered	34
Powered	35
Extension Element, 120° 3 Pack	
Non-Powered	36
Powered	37

### STAND-ALONE ELEMENTS

Stand-Alone Element, Single-Sided	
Non-Powered	39
Powered	40
Stand-Alone Element, Double-Sided	
Non-Powered	42
Powered	43
Stand-Alone Element, 120° 3 Pack	
Non-Powered	44
Powered	45

## WORKSURFACE SUPPORTS

Worksurface Supports, Single-Sided	
For Start/End of Run	46
For Center of a Run	48
Worksurface Supports, Double-Sided	
For Start/End of a Run	50
For Center of a Run	50
Taper & Inset: End of Run Support	51
Double Sided, Taper & Inset: Center of Run	53

### SUPPORTING STORAGE

Pedestals and Credenzas	54
Cabinets	57
Attachment Brackets	58

### GALLERY PANELS

Gallery Panels, End of Run	59
----------------------------	----

### ELECTRICAL DISTRIBUTION

Electrical Distribution	61
Power Grommets	65

### MY-HITE WORKSURFACE

Rectangular	66
Rectangular Extension	67
Wedge	68
D-Shaped	69
120° Corner / 90° Ends	70
120° Corner / 120° Ends	70
Corner	71
90° Extended Curved Corner	72

Ordering Verity Accessories & Storage	75
---------------------------------------	----

Return Worksurface	76
--------------------	----

## STORAGE

Mobile Pedestals	
Laminate	77
Metal	78
My-Hite	79
Credenzas	80
Cabinets	82
Over-Worksurface Storage	
Single-Sided	83
Double-Sided	85
Pulls	87
Supports	89

## TRACK-MOUNTED ACCESSORIES

Fabric Tackboard	90
Glass Screen	91

## WORKSURFACE-MOUNTED ACCESSORIES

Privacy Screen, Fabric	92
Privacy Screen, Marker Board	93
Privacy Screen, Laminate	94
Modesty Panel, Laminate	95
Fabric Tackboard	96
Glass Screen	97
Markerboard Screen	97
Modesty Panel, undersurface mounted	97
Supporting Brackets	98
Desk Mounted Power Unit	98
Mesh Wire Manager	98
Monitor Arm	99
Keyed-Alike	99

## Terms and Conditions

---

### PRICES

All Prices are F.O.B. point (Continental U.S.). We reserve the right to change prices without prior notice. See Friant policy at [www.Friant.com](http://www.Friant.com)

### ORDERING

Purchase Orders should be sent to Friant & Associates, LLC at [orders@friant.com](mailto:orders@friant.com), or faxed to (510) 535-6895. If your specifications were created with CAP, GIZA, or Project Matrix please send the worksheet (SP4) with your Purchase Order.

### TERMS

Net 30 days from date of invoice. Invoices are delinquent if not paid 30 days from date of invoice. In the event timely payment is not made, interest will be charged at the rate of 1.5% per month on delinquent accounts. Buyers will also be liable for normal collection costs and attorney's fee. 50% deposit is required with every order, unless prior arrangements have been made.

### ORDERS

Orders are only accepted by issuance of our formal acknowledgment, and are subject to the terms set forth herein and on our order acknowledgment. It is the responsibility of the buyer to review our acknowledgment for accuracy.

### LEAD TIME

Lead times are subject to availability.

### SHIPPING

Friant generally palletizes, boxes and/or shrink-wraps its products. If buyer requests additional packaging or special shipping, then it is responsible for any extra costs that result. Buyer obtains title to products and assumes the risk of loss for them upon shipment from Friant's plant.

### CLAIMS

We are not responsible for damage suffered in transit. Merchandise should be inspected for possible freight damage upon delivery. The consignee should file for damage or shortages with the carrier within 5 days of delivery. You are also protected for "concealed damage" if you file claim with the carrier within 5 days of delivery. Buyer must make all claims against Friant for defects, errors or shortages in writing within 10 days after delivery. Failure to make such a claim shall constitute full acceptance.

### RETURNS

No merchandise may be returned without our written consent and shipping instructions. Unauthorized returns will not be accepted and will be returned freight collect.

### PARTIAL SHIPMENTS

We will make every attempt to ship orders complete and on schedule. However, we reserve the right to make partial shipments, as merchandise is ready. Invoices covering these shipments are to be paid as they become due.

### ORDER CHANGE – CANCELLATIONS

Our order confirmation is final and binding. Any order change or cancellation is subject to our ability to conform. For the most up to date information, always review the order change/cancellation policy online. Allowable changes within the posted policy must be made in writing.

### SHIPMENT AND PREPAID FREIGHT

Unless otherwise instructed, we reserve the option to ship by what is, in our opinion, the best possible way. Upon request, we will prepay and add freight for accounts with established credit.

### DELIVERY

We are not liable for delay or failure of delivery due to strikes and/or differences with workmen, war, riot, fire, compliance with government regulations, acts of nature, failure or delays of sources of supply, or any other causes beyond our control.

### STORAGE

If buyer cannot accept delivery when merchandise is ready, we reserve the right to transfer goods to storage. Costs of transfer and storage will be charged to the buyer's account, and we will deem such transfer as constituting shipment for all purposes, including invoicing, as of the date the transfer is made.



## Terms and Conditions continued

### CONSTRUCTION — SPECIFICATIONS

All items are produced to price list specifications unless otherwise advised. All dimensions shown are approximate. Manufacturer reserves the right to make modifications and/or improvements without prior notice.

### FABRIC APPLICATION

Standard fabric application is **non-directional**.

Friant & Associates is not responsible for charges associated with replacement of products due to incorrect specifications. Please note:

**Certain product construction and sizes require fabric to be applied only Directionally or Non-Directionally.** See individual pricebook specifications for details.

### CUSTOMER'S OWN MATERIAL

Yardage requirement is based on 66" wide plain covering material, and must be increased if less than 66" wide. Special instructions for handling material (pattern, directional fabric, right side of reversible fabric, etc.) must be submitted in writing before fabric is delivered. In the absence of special instructions, we reserve the right to use our own judgment. We reserve the right to reject any covering, which in our opinion, is unsuitable for our upholstery purposes. However, in no instance shall we be held responsible for unsatisfactory results due to use of covering unsuitable for our upholstery methods.

We will not be responsible for errors caused by buyers not supplying us with sample cuttings attached to their order giving full identification of covering material, (name of supplier, covering name, number and color) for identification purposes and advising us of model number and quantity to which each cover is to be applied.

Customer's own material that is shipped freight collect will be refused. A service charge will be applied for the return of unusable C.O.M. Contact factory.

### RIGHTS AND WARRANTIES — LIMITED LIFETIME WARRANTY

This warranty is given to the initial purchaser and is valid from the date of purchase, for as long as the initial purchaser owns the product. This warranty covers defects in material and craftsmanship found during normal usage of the product during the warranty period. Normal usage is defined by 8 hour shifts in the product's intended application and in an indoor environment that conforms to the ANSI/ASHRAE Standard 55: Thermal Environmental Conditions for Human Occupancy (relating to air temperature, mean radiant temperature, air velocity, clothing insulation, metabolic rate, and humidity). Friant's warranty does not cover usage other than normal usage as defined in the previous sentence. If the product is defective, and if written notice of the defect is given to Friant & Associates within the applicable warranty period, Friant & Associates, at its option, will either repair or replace the defective product with a comparable component or product. This warranty applies to all products except as noted below.

High wear parts, such as wood veneer, fabrics, laminates, and other covering material/finishes, foam, glides, etc. are warranted for one (1) year. This warranty does not apply to damage caused by a carrier, alteration to the product not expressly authorized by Friant & Associates, nor to product considered to be of a consumable nature such as bulbs, light ballasts, etc. It also does not apply to "Customer's Own Material" (i.e. material specified by the customer that is not a standard Friant & Associates offering) used in the manufacture of Friant & Associates products.

Our warranty for LED lights is 2 years.

Friant & Associates does not warrant the matching of colors, grain or texture, except to within commercially acceptable standards. This includes normal variations between dye lots (fabrics).

A product will not be considered defective, and Friant & Associates will not be obligated to replace it, if it is not installed in a proper manner (i.e. product not leveled, not secured properly, etc.) or if it is not used in a manner and/or in an environment that constitutes normal usage, as defined above.

Except as noted above, Friant & Associates makes no express or implied warranties to any product, and in particular makes no warranty of fitness for any particular use. At Friant & Associates' option, product repair and replacement is the customer's exclusive remedy for any and all product defects.

Friant & Associates shall not be liable for consequential, economic, or incidental damages arising from any product defect.

## Terms and Conditions continued

---

### **CALIFORNIA PROP 65 WARNING**

Products in this catalog can expose you to chemicals including wood dust, which is known to the State of California to cause cancer or birth defects or other reproductive harm. For more information go to <https://www.p65warnings.ca.gov/products/furniture-products>."

### **CARB**

Friant products are CARB 93120 compliant for formaldehyde (phase 2)

### **TSCA TITLE VI**

Friant products are TSCA Title VI Compliant

### **MAS**

Accredited Compliance Designation - ANSI/BIFMA x7.1 & e3-2014 7.6.1, 7.6.2, 7.6.3  
California Dept. Of Public Health Standard Method v1.2

Conforms With: LEED v4

Criteria of MAS Certified Green ® Program

## Standard Fabrics

JOURNEY		TERRAIN		SLIDE		SILKY		SKY	
PF801-1	Quest	PF701-1	Cloud	PF101-1	Caramel	PF401-1	Natural	PF301-1	Terra
PF801-2	Voyage	PF701-2	Dusk	PF101-2	Slate	PF401-2	Parids	PF301-2	Birch
PF801-3	Transit	PF701-3	Wave	PF101-3	Pewter	PF401-3	Overcast	PF301-3	Moss
PF801-4	Amble	PF701-4	Earth	PF101-7	Java	PF401-5	Graphite		
PF801-5	Odyssey			PF101-9	Sterling				
PF801-6	Caravan			PF101-10	Crema				
PF801-7	Expedition			PF101-13	Mustard				
PF801-8	Wayfare			PF101-14	Avocado				
				PF101-15	Pumpkin				
				PF101-16	Ocean				
				PF101-17	Blueberry				
				PF101-18	Cardinal				
				PF101-19	Flamingo				
				PF101-20	Serenity				
				PF101-21	Azure				
				PF101-22	Orchid				
				PF101-23	Plum				
				PF101-24	Raven				

### LIMITED AVAILABILITY

SLIDE		STICKS		PASSAGE	
PF101-4	Verde	PF501-3	Sage	PF601-5	Leaf
PF101-6	Vintage			PF601-8	Amber
PF101-8	Latte				

**Fabric is scheduled for discontinuation when inventory is exhausted. Please contact Customer Success for current stock levels. After discontinuation fabric will be available with extended lead time, subject to minimum yardage requirements.**

NOTE:

- Fabric direction as per Friant's fabric card.
- All textiles listed are 66" wide.
- Order fabric/finish sample online at [www.friant.com](http://www.friant.com)
- Colors may vary slightly between dye lots.
- **Passage and Terrain are not available on acoustical panels, pedestal cushions, tackboards or fabric screens..**
- Please consult your Friant sales consultant for:
  - Other colors not listed above
  - C.O.M. fabric

## Pattern Direction

- Fabric direction is not always determined by the way the pattern is shown on memo sample.
- Certain product construction and sizes require fabric to be applied only Directionally or Non-Directionally.
- Some products have fabric applied either Directionally or Non-Directionally. (Upcharges may apply on some products, see price books for details).
- Please refer to our Materials Reference Guide on the Dealer Resource Center for specific pattern application defaults on all of our products: <http://dealers.friant.com/dealers/product-literature/>
- Our Customer Success Team is happy to answer any questions regarding fabric direction.

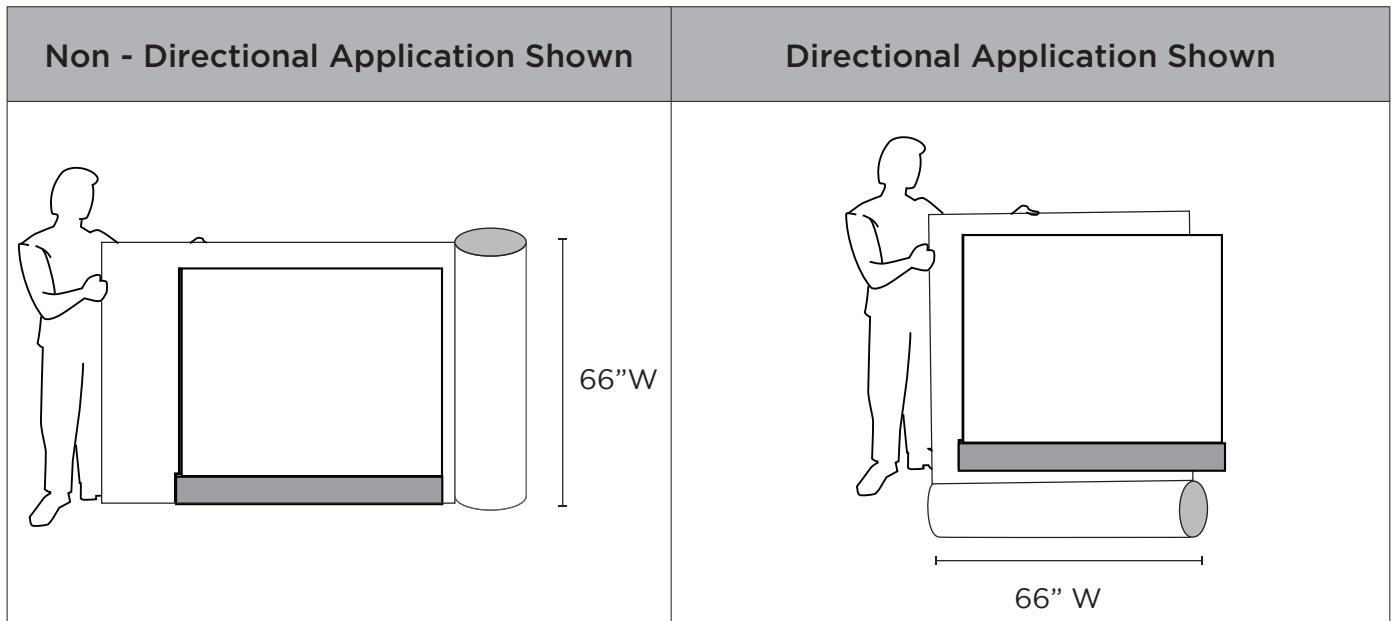

## Standard Finishes

For matching edge PVC, please read across matrix.

WORKSURFACE LAMINATES		EDGE LAMINATES (3MM PVC)	
M1	Light Maple	E1	Light Maple
M2	Light Cherry	E2	Light Cherry
M3	Medium Cherry	E3	Medium Cherry
M4	Dark Mahogany	E4	Dark Mahogany
M6	Light Gray	E6	Light Gray
M9	Cloud White	E9	Cloud White
M10	Espresso	E10	Espresso
M11	Light Walnut	E14	Light Walnut
M12	Medium Walnut	E15	Medium Walnut
M13	Licorice	E13	Licorice
M14	Carob	E17	Carob
M16	Tundra	E19	Tundra
M18	Capitan	E21	Capitan
M19	Fog	E22	Fog
M20	Sandstone	E23	Sandstone
M23	Bark	E26	Bark
M25	Winter	E28	Winter
M26	Storm	E29	Storm
M27	Medium Ash	E30	Medium Ash
M28	Arctic	E31	Arctic
M29	Raven	E32	Raven
M30	Barley	E33	Barley
M31	Camel	E34	Camel

Complimentary Edge Finishes	
E8	Black Umber
E11	Medium Tone
E12	Dark Tone

Complimentary edge finishes have no exact laminate match available

Order samples at [www.friant.com](http://www.friant.com)

**Please Note:** Images are printed simulations and are not exact matches of finished product. Please request an actual sample from Friant or your sales consultant before specifying finishes.

### PAINT FINISH

- BU Black Umber
- CW Cloud White
- SV Silver

### GROMMET COLORS

- BU Black Umber
- CW Cloud White
- SV Silver

### MY-HITE PED FOAM CUSHION

- Red
- Charcoal
- Café
- Grey

### MY-HITE COLOR PEDESTAL TOP

- Green
- Blue
- Red



## Credenza, Pedestal, Lateral File and Freestanding Tower Handles

You have multiple handle options for handles for your FRIANT storage. Please specify which handle you would like when ordering. For any questions, please call Friant Customer Success or your sales rep.

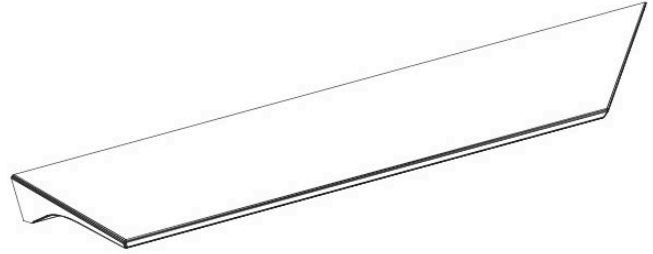

### WEDGE PULL

Available in Brushed Aluminum, Black Umber

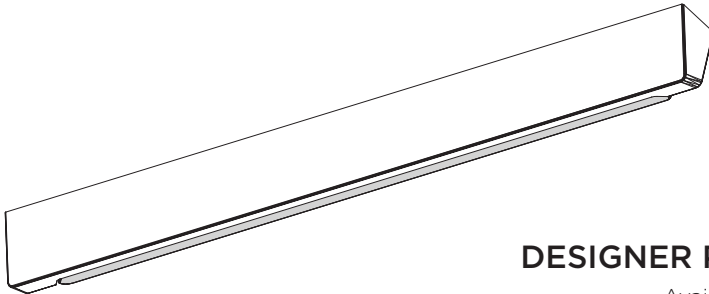

### DESIGNER PULL

Available in:

Cloud White/Red, Cloud White/Green, Cloud White/Grey

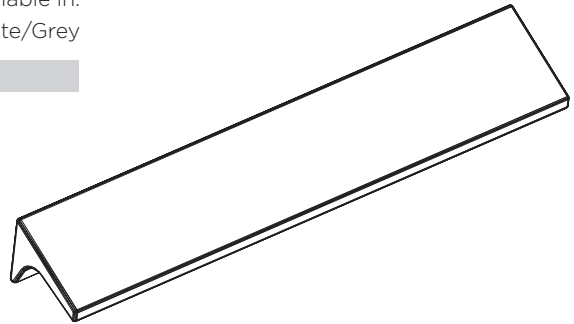
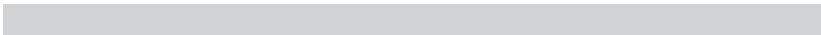

### SLANT PULL

Available in Brushed Aluminum, Black Umber

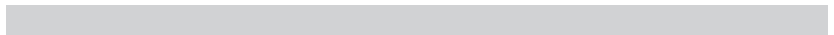

## Ordering Verity: Elements

### Verity benching can be ordered as Elements.

See below for further details about Elements and a guide on how to order.

## Elements

Elements are parts to build a larger and more customized complete unit. They are not freestanding, must be combined with other elements, and require ordering supports separately. An Element consists of structure and worksurface only.

There are three types of Elements:

- Starter/End Elements

- Extension Elements

- SA Elements (Stand Alone)

- \* Starter/End Elements are required at both the start and end of every run. Extension Elements are used anywhere between the Starter and End Elements.
- \* Support options for Elements include legs, pedestals, cabinets or credenzas.
- \* Additions, such as storage and accessories, are not included and need to be ordered separately.
- \* Available single-sided or double-sided, either non-powered or powered.
- \* Verity runs should not exceed 25'

## How to Order Elements

### 1 Build a run with Starter/End and Extension Elements.

First, select a Starter/End Element to start the run. Next, select one or more Extension Elements to extend the run. Last, select a Starter/End Element to end the run.

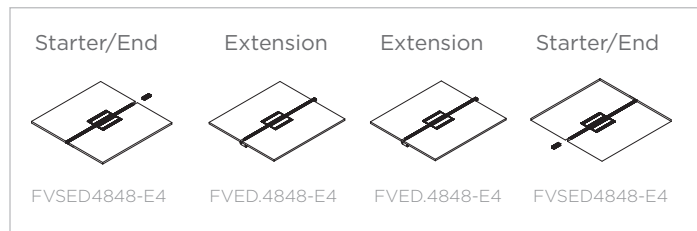

### 2 Select the supports.

Starter/End Elements can be supported by legs or supporting storage. Extension Elements can be supported by open center legs, enclosed center legs or credenzas.

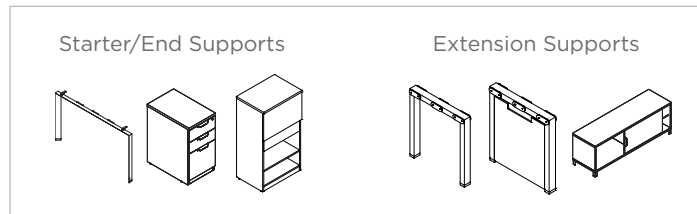

All storage supports require ordering attachment brackets separately.

### 3 Order electrical components, as necessary.

Order infeeds, duplexes and power jumpers from page 61.

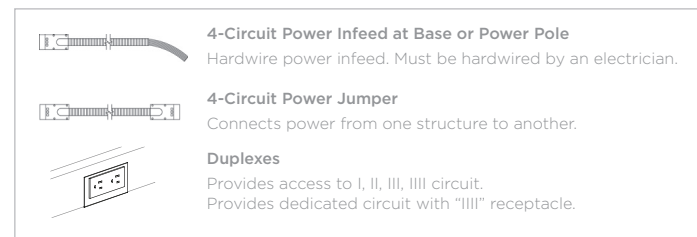

### 4 Optional: Select Additions to complete your unit.

For all specification options and details, please reference the corresponding page from the table of contents.

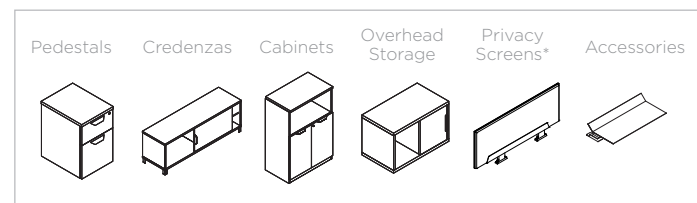

\*Available as fabric, tackboards, glass, and markerboards  
\*Not to exceed 20'

## How to Specify Support Selections in Verity Elements

Verity Double Sided Start/End and Stand Alone Elements have an option for the type of Support Bar. Specify the **Support Selection** on the Verity Element based on the type of legs used.

Please note: There is no Support Selection option for Extension Elements or any Single Sided Elements. Only straight support bars would be needed.

### 1 Select a Verity Element:

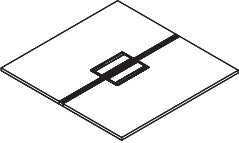
Choose	Specify Part #	Specify Options
	FVSED.4848-N	Worsksurface Finish Edge Finish Finish Support Selection

### 2 Specify Support Selection

Support Selection is determined based on the type of leg used.

**CONCAVE** supports are needed on the side of an Element supported by Concave Taper Start/End legs or Concave Inset Start/End

Concave Legs

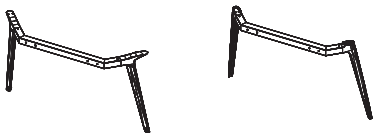

**STRAIGHT** supports are needed on the side of an Element supported by all other Start/End legs, Center Legs, or Supporting Storage

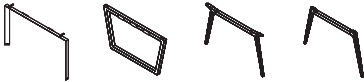
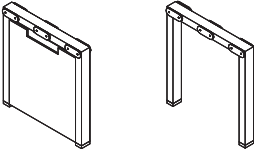
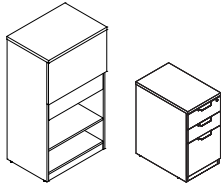
Straight Legs	Center Legs	Supporting Storage
		

How to Specify Support Selections in Verity Elements *continued.*

INTRODUCTION

**2a** Support Selection for Start/End Element, Double Sided

Choose

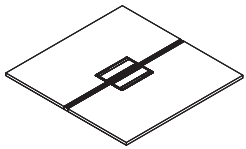

Examples

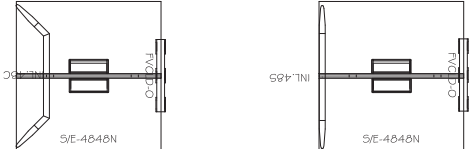

CON1SD                      STRAIGHT LEG

Code	Description
CON1SD	Concave 1 sided
STRAIGHT LEG	Straight Leg Selection

**2b** Support Selection for Stand Alone Element, Double Sided

Choose

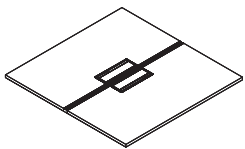

Examples

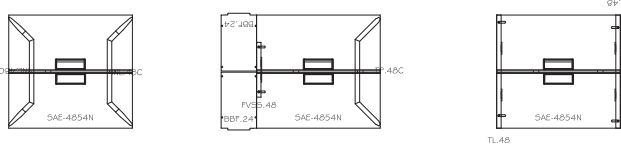

CON2SD                      CON1SD                      STRAIGHT LEG

Code	Description
CON2SD	Concave 2 sided
CON1SD	Concave 1 sided
STRAIGHT LEG	Straight Leg Selection

**How to Specify Support Selections in Verity Elements** continued.

**2c Support Selection for Start/End Element, 120 °**

Choose

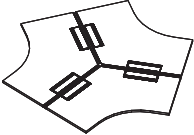

Example

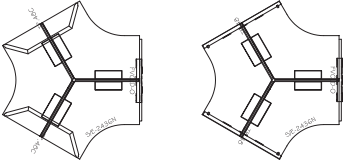

CON2SD      STRAIGHT LEG

Code	Description
CON2SD	Concave 2 sided
STRAIGHT LEG	Straight Leg Selection

**2d Support Selection for Stand Alone Element, 120 °**

Choose

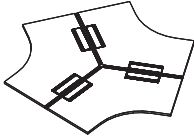

Examples

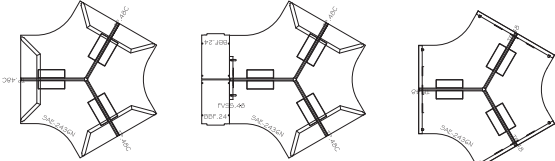

CON3SD      CON2SD      STRAIGHT LEG

Code	Description
CON3SD	Concave 3 sided
CON2SD	Concave 2 sided
STRAIGHT LEG	Straight Leg Selection

## Powering Verity

### A guide to ordering electrical components for Verity benching.

See below for further details about running electrical/data.

## Connecting to Power

Power can be brought in 3 different ways, which are all shown below.

Select the option that best fits the needs of the space and order from the components shown on page 33.

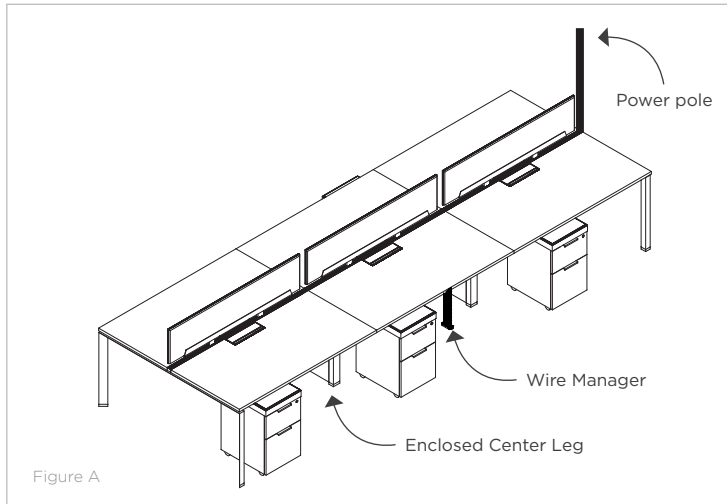

- Wire Manager + Infeed  
connect power anywhere along the run and use the wire manager to conceal wires.
- Power Pole  
may be used only at the start or end of a run.
- Enclosed Center Leg + Infeed  
connect power at the center of a run and conceal wires inside the leg.

## Power Distribution

To bring power from one Element to another, order a 4-circuit power jumper.

### Power Jumper for 96”W Elements

When connecting power for a 96”W element, use 48”W jumper.

96” wide elements require a 48” power jumper in the center in addition to the jumper connecting adjacent elements.

Power Jumper Sizing Chart

	48	54	60	66	72	78	84
48	FVJUMP.48	FVJUMP.54	FVJUMP.54	FVJUMP.60	FVJUMP.60	FVJUMP.66	FVJUMP.66
54	FVJUMP.54	FVJUMP.54	FVJUMP.60	FVJUMP.60	FVJUMP.66	FVJUMP.66	FVJUMP.72
60	FVJUMP.54	FVJUMP.60	FVJUMP.60	FVJUMP.66	FVJUMP.66	FVJUMP.72	FVJUMP.72
66	FVJUMP.60	FVJUMP.60	FVJUMP.66	FVJUMP.66	FVJUMP.72	FVJUMP.72	FVJUMP.78
72	FVJUMP.60	FVJUMP.66	FVJUMP.66	FVJUMP.72	FVJUMP.72	FVJUMP.78	FVJUMP.78
78	FVJUMP.66	FVJUMP.66	FVJUMP.72	FVJUMP.72	FVJUMP.78	FVJUMP.78	FVJUMP.84
84	FVJUMP.66	FVJUMP.72	FVJUMP.72	FVJUMP.78	FVJUMP.78	FVJUMP.84	FVJUMP.84

## Power Duplexes

Order two duplexes per workstation.

Duplexes provide access to I, II, III, and IIII circuits. Use receptacle IIII for a dedicated circuit.



## Double Sided to Single Sided, End of Run

- Verity offers Stand-Alone Elements sized specifically for placement at the end of Double-Sided runs
  - **FVSAES.2450-E4** (page 41) or **FVSAES.2450-N** (page 39) for use with 48”D Elements
  - **FVSAES.2462-E4** (page 41) or **FVSAES.2462-N** (page 39) for use with 60”D Elements
- Specify Double-Sided Elements and Supports to complete a freestanding Double-Sided cluster. Add Single Sided Stand-Alone Elements and supports to finish the run
- Add (1) **FV-DCT** Double-Sided Connecting Trough and (1) **FVJUMP.48** Jumper to bring the power from Double Sided cluster to Single-Sided Element
- Add (1) **FVFB.08** Flat Bracket pair to tie together the Double-Sided Elements to the Single Sided Stand-Alone
  - This does not provide support, aligns tops only. Double and Single-Sided legs need to be specified for support

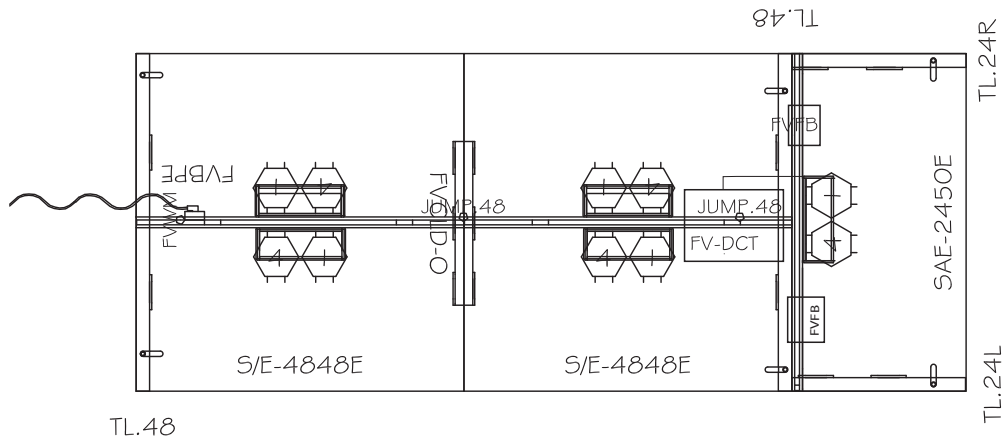

## Double Sided to Single Sided, Inline

- Specify Double-Sided Elements and Supports to complete a freestanding Double-Sided cluster. Add Single-Sided Stand-Alone Elements and supports to finish the run
- Add (1) **FV-DCT** Double-Sided Connecting Trough and (1) **FV-SCT** Single-Sided Connecting Trough to bring the power from Double-Sided cluster to Single-Sided Element
- Specify Jumper of appropriate length, see Power Jumper Sizing Chart for reference (page 63)
- Add (1) **FVFB.08** Flat Bracket pair to tie together the Double-Sided Elements to the Single Sided Stand-Alone
  - This does not provide support, aligns tops only. Double and Single-Sided legs need to be specified for support

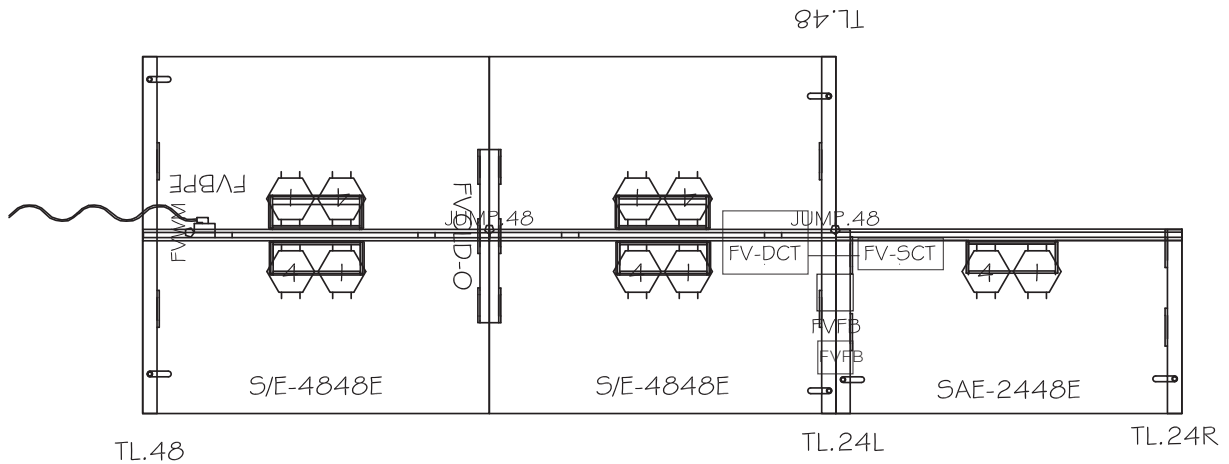

# Grommet Locations

INTRODUCTION

## 1 Select a My-Hite worksurface

My-Hite tops (see page 66) offer optional grommets. (Please use the codes shown when specifying location of grommets). An upcharge of \$75 applies per grommet.

Choose 	Specify Part # FVECCWS.23346423R	Specify worksurface and edge M16 Tundra E19 Tundra
--	-------------------------------------	--

## 2a Select a grommet location, Rectangular Tops

Specify location by using the designated codes

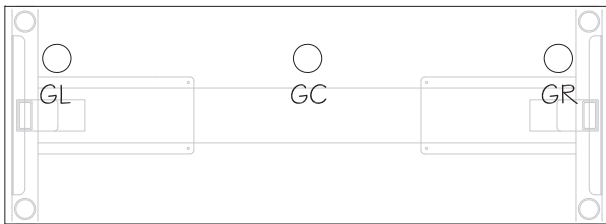

CODE POSITION

GL	4" from left side - 4" from rear
GC	Centered from side to side - 4" from rear
GR	4" from right side - 4" from rear
G1	Pair of grommets, GL and GR
G5	Three grommets, GL-GC-GR

Dimensions are measured from grommet center

For other grommet locations, please call Friant Customer Success.

Grommets are 3" round with cover standard

## 2b Select a grommet location, Extended Corner Tops

Specify location by using the designated codes

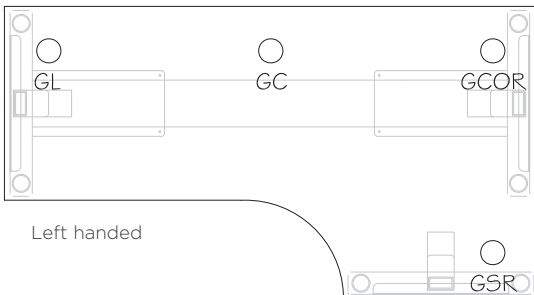

Left handed

Extended Corner, Left Handed

CODE POSITION

GL	4" from left side - 4" from rear
GC	Centered from side to side - 4" from rear
GCOR	Corner, 4" from Rear
GSR	4" from right side - 4" from rear

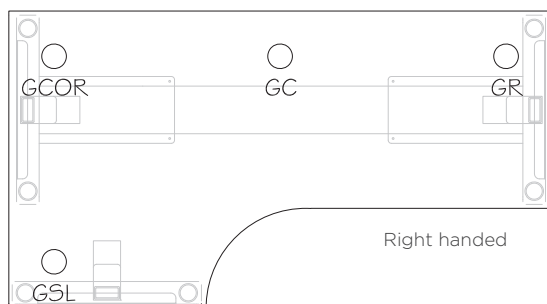

Right handed

Extended Corner, Right Handed

CODE POSITION

GCOR	Corner, 4" from Rear
GC	Centered from side to side - 4" from rear
GR	4" from right side - 4" from rear
GSL	4" from left side - 4" from rear

Dimensions are measured from grommet center

For other grommet locations, please call Friant Customer Success.

Grommets are 3" round with cover standard

## Grommet Locations

### 2c Select a grommet location, D-Shaped Tops

Specify location by using the designated codes

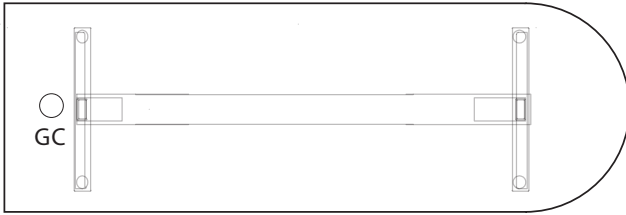

CODE	POSITION
GC	Centered from side to side - 4" from rear

Dimensions are measured from grommet center

For other grommet locations, please call Friant Customer Success.

Grommets are 3" round with cover standard

### 2d Select a grommet location, 120° Tops

Specify location by using the designated codes

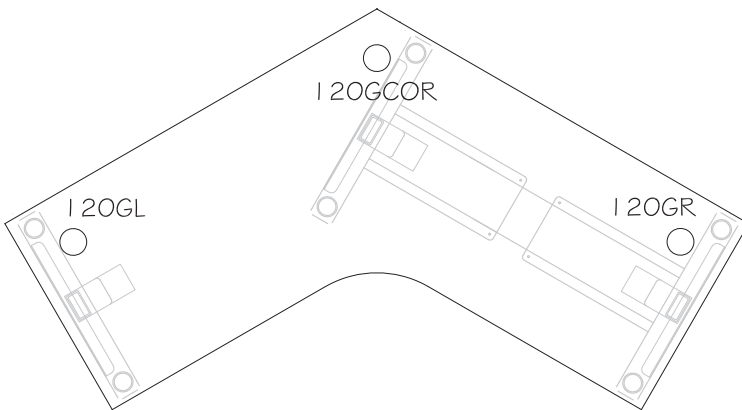

CODE	POSITION
120GL	4" from left side - 4" from rear
120GCOR	Corner - 4" from rear
120GR	4" from right side - 4" from rear

Dimensions are measured from grommet center

For other grommet locations, please call Friant Customer Success.

Grommets are 3" round with cover standard

### 2e Select a grommet location, 90° Equal Corners

Specify location by using the designated codes

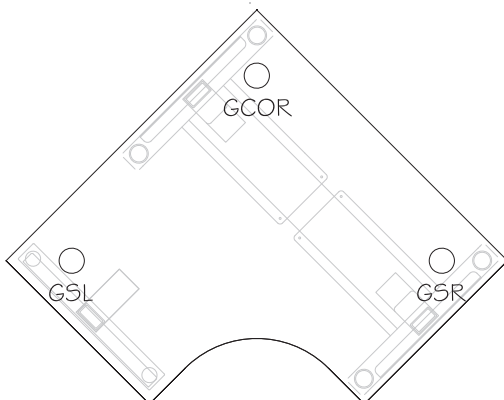

CODE	POSITION
GSL	4" from left side - 4" from rear
GCOR	Corner - 4" from rear
GSR	4" from right side - 4" from rear

Dimensions are measured from grommet center

For other grommet locations, please call Friant Customer Success.

Grommets are 3" round with cover standard

## Power Grommet Locations - Notch Cutouts, My-Hite Worksurfaces

FRIANT Power Grommet notch cutouts are required when specifying a Power Grommet on a worksurface supported by a My-Hite C-Leg adjustable height table base. Choose the size of power grommet (5x8 only) and cutout location (left, center or right). Specify Power Grommets on page 65 . An upcharge of \$75 applies for cutouts.

NOTE: Notch cutouts only available with 5x8 Power grommets and C-leg bases.

INTRODUCTION

### 1 Select a My-Hite worksurface

My-Hite worksurfaces (starting on page 26)

### 2 Select a power grommet notch cutout location

CODE	POSITION
PG5L-C	11" from left side
PG5C-C	Centered
PG5R-C	11" from right side

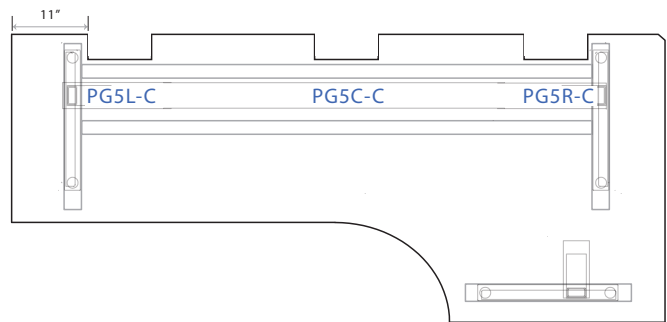
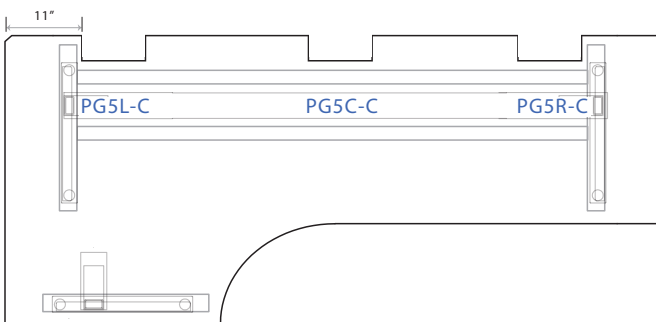
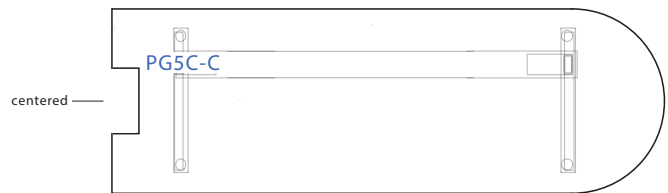
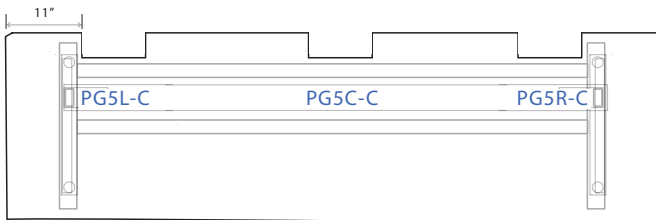

### 120° and 90° worksurfaces

CODE            POSITION (Specific to 120° and 90°)

PG5L-C	4.5" from left side
PG5R-C	4.5" from right side

Positions for 120° worksurfaces:

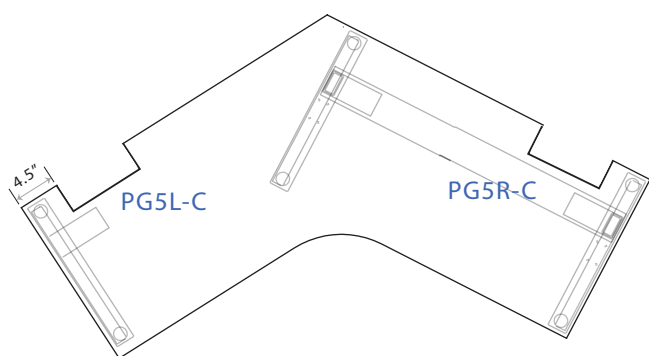

Positions for 90° equal corner worksurfaces:

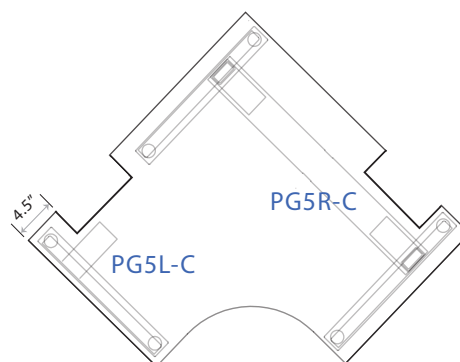

## Power Grommet Locations - Interior Cutouts, My-Hite Worksurfaces

FRIANT Power Grommet interior cutouts are used when specifying a Power Grommet on a worksurface supported by a My-Hite T-Leg adjustable height table base. Choose the size of power grommet (5x8 or 6x8) and cutout location (left, center or right). Specify Power Grommets on page 65. An upcharge of \$75 applies for cutouts.

NOTE: Standard position Interior cutouts are not compatible with C-leg bases.

### 1 Select a My-Hite worksurface

My-Hite worksurfaces (starting on page 26)

### 2 Select a power grommet interior cutout location

CODE	POSITION
PG6L	11" from left side, 1.5" from back
PG6C	Centered, 1.5" from back
PG6R	11" from right side, 1.5" from back
PG5L	11" from left side, 1.5" from back
PG5C	Centered, 1.5" from back
PG5R	11" from right side, 1.5" from back

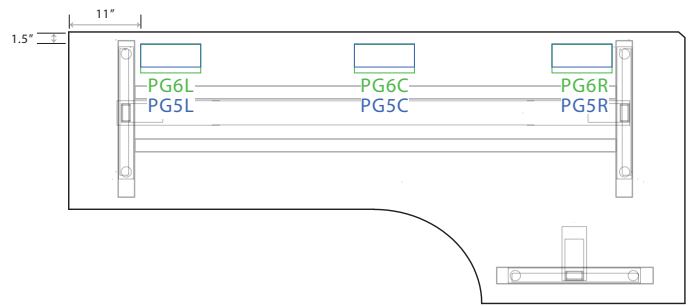
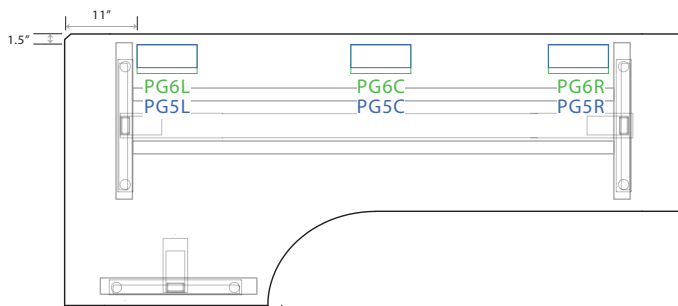
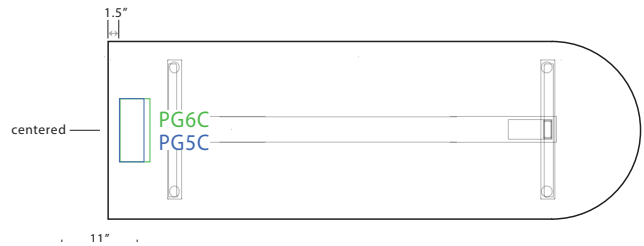
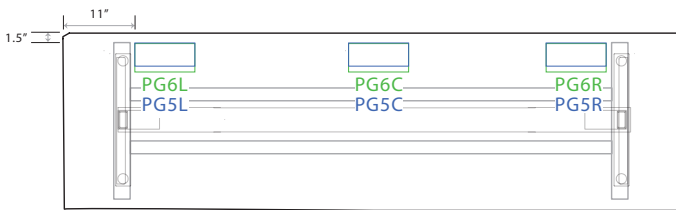



**120° and 90° worksurfaces**

CODE	POSITION (Specific to 120° and 90°)
PG6L	4.5" from left side, 1.5" from back
PG6R	4.5" from right side, 1.5" from back
PG5L	4.5" from left side, 1.5" from back
PG5R	4.5" from right side, 1.5" from back

**Positions for 120° worksurfaces:**

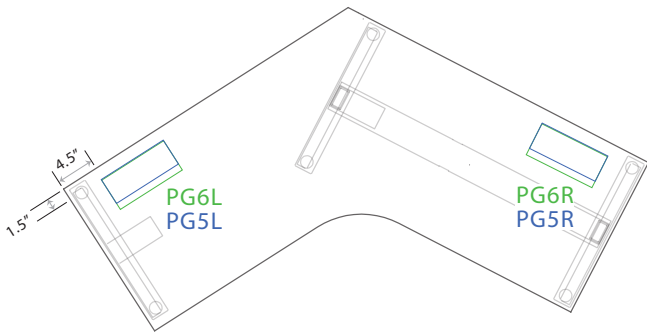

**Positions for 90° equal corner worksurfaces:**

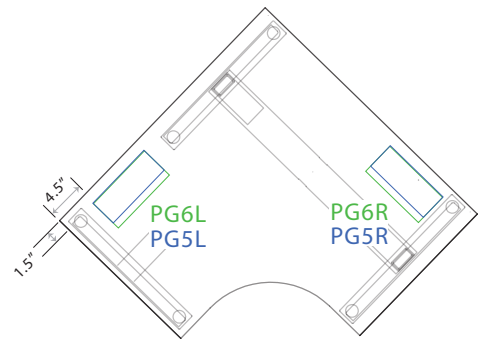

## Power Grommet

FRIANT power grommets are available to meet different worksurface power and data needs. Choose the color of the power grommet (brushed aluminum, brushed charcoal, or cloud white). Specify power grommets on page 65.

### 3 FINISHES AVAILABLE

Brushed aluminum, brushed charcoal and cloud white

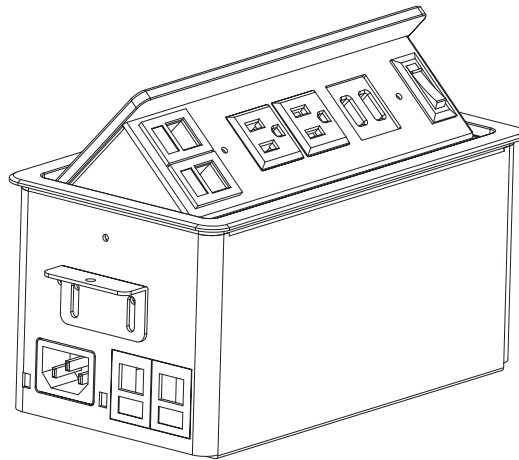
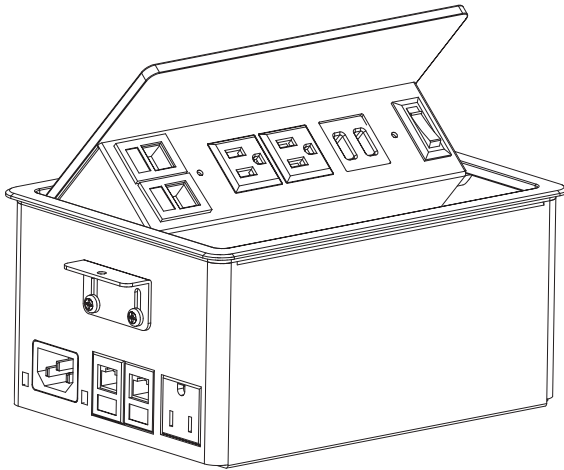

### INCLUDES SPRING CORD

(Not shown) For connection to power source

### POWER GROMMETS

#### 6x8

- (2) CAT6 Data Ports
- (4) Power Outlets
- (2) USB Ports

#### 5x8

- (2) CAT6 Data Ports
- (3) Power Outlets
- (2) USB Ports

## Data Port Plate

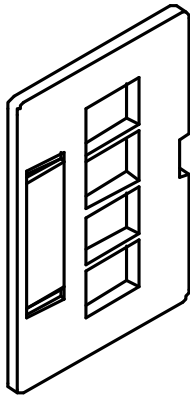
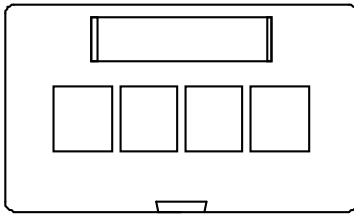

### Product Description

PART #: FVDPP

This Data Port Faceplate is field configurable, flush-mounted onto the Panel Base Kickplate, and provides 1 to 4 flush-mount ports for a variety of snap-in connectors and adaptors.

#### Product Notes

- Installation and changes can be made without removing the Panel Base Kickplate
- Plates can be installed and removed without any tools
- Window ID provided with each Data Port Plate
- Release latch provides easy access to connections without any tools
- Blank inserts included with each Data Port Plate

#### Dimensions

PART #: FVDPP

HEIGHT: 3<sup>5</sup>/<sub>8</sub>"

WIDTH: 2<sup>1</sup>/<sub>8</sub>"

DEPTH: 0.25" (from face of Panel Base Kickplate)

MATERIAL: High impact plastic

## How To Specify My-Hite 2-Piece Extended Corner or Rectangular Tops

Use a FVFB.08 Flat Bracket pair to attach the two surfaces, making sure the seam is oriented so that it is supported by the continuous part of the My-Hite Corner Base. Maximum width combined: 84x84" (All My-Hite bases) or 72x96" (3 Stage base only).

Specify the Rectangular Extension on page 67.

To create an extended corner My-Hite station, specify an Extended Curved Corner with a Rectangular Extension.

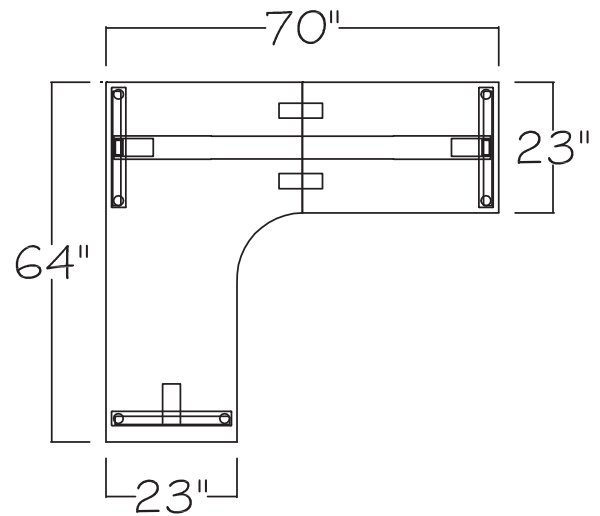
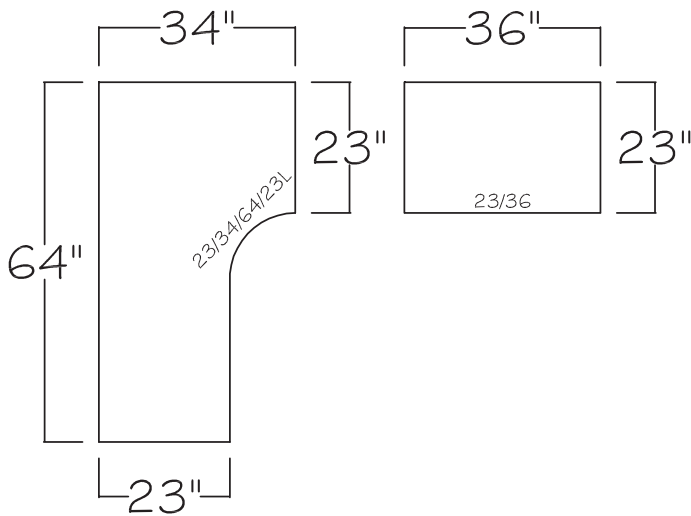

To create a two piece rectangular corner top, specify two rectangular tops, or a rectangular top and one rectangular extension.

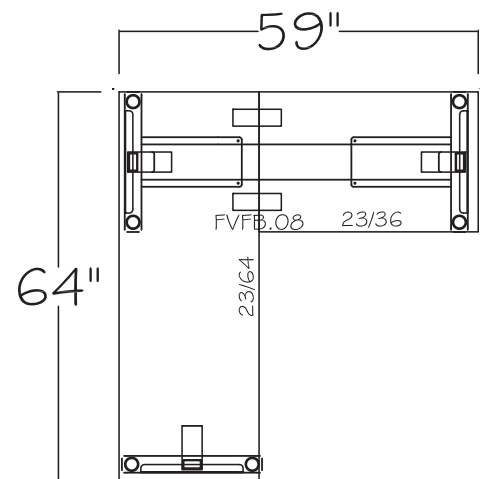
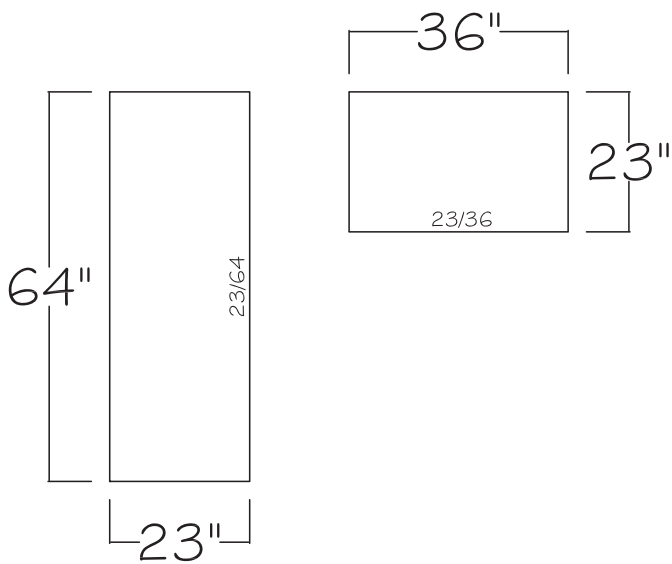

# ELEMENTS

## Starter/End Element, Single-Sided NON-POWERED

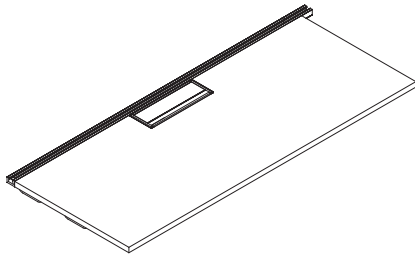

### DESCRIPTION

Starter/End Elements are required at the start and end of every run.

Includes a support structure with wire management trough, and work surface with access grommet.

### NOTES

Starter/End Elements:

- Order another Starter/End Element (required) separately to complete run.
- Order Extension Elements (optional) to expand a run.
- Order supports separately (supporting legs, pedestals, cabinets, credenzas).
- 96"W worksurfaces have two grommets.
- 96" wide elements require a center support leg (ordered separately)

### SPECIFICATION OPTIONS

**product #:** see charts below  
**worksurface finish:** see page 8  
**edge finish:** see page 8  
**finish:** see page 8

### ORDER EXAMPLE

**product #:** FVSES.2448-N  
**worksurface finish:** M1 Light Maple  
**edge finish:** E1 Light Maple  
**finish:** CW Cloud White

STARTER/END ELEMENTS

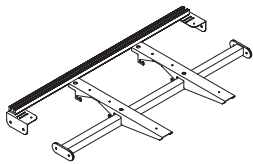

Support Structure

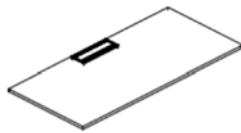

Worksurface

### NON-POWERED, 24" DEPTH

PART #	HEIGHT	WIDTH	DEPTH	WT. (LBS)	LIST
FVSES.2448-N	—	48"	25.5"		\$1,623
FVSES.2454-N	—	54"	25.5"		\$1,693
FVSES.2460-N	—	60"	25.5"		\$1,795
FVSES.2466-N	—	66"	25.5"		\$1,882
FVSES.2472-N	—	72"	25.5"		\$1,967
FVSES.2478-N	—	78"	25.5"		\$2,139
FVSES.2484-N	—	84"	25.5"		\$2,139
FVSES.2496-N	—	96"	25.5"		\$2,967

### NOTES

### NON-POWERED, 30" DEPTH

PART #	HEIGHT	WIDTH	DEPTH	WT. (LBS)	LIST
FVSES.3048-N	—	48"	31.5"		\$1,693
FVSES.3054-N	—	54"	31.5"		\$1,771
FVSES.3060-N	—	60"	31.5"		\$1,880
FVSES.3066-N	—	66"	31.5"		\$1,936
FVSES.3072-N	—	72"	31.5"		\$2,068
FVSES.3078-N	—	78"	31.5"		\$2,162
FVSES.3084-N	—	84"	31.5"		\$2,256
FVSES.3096-N	—	96"	31.5"		\$3,194

### NOTES



# Starter/End Element, Single-Sided POWERED

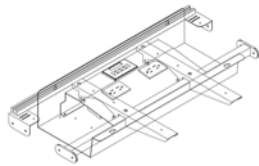
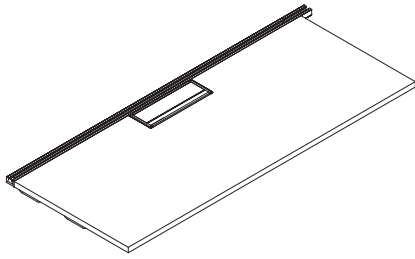

**Support Structure**

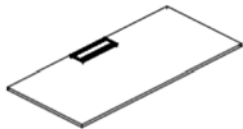

**Worksurface**

**DESCRIPTION**

Starter/End Elements are required at the start and end of every run.

Includes a support structure with 4-circuit power block, wire management trough, and worksurface with access grommet. Data Port Plates are included

**NOTES**

- Starter/End Elements:
- Order another Starter/End Element (required) separately to complete run.
  - Order Extension Elements (optional) to expand a run.
  - Order supports separately (supporting legs, pedestals, cabinets, credenzas).
  - 96"W worksurfaces have two grommets.
- Powered:
- Includes a 4-circuit power block.
  - Order 4-circuit power infeed, jumper, and duplexes separately.
  - Each grommet has 2 duplex locations
  - 96" wide elements require a center support leg (ordered separately)
  - 96" wide elements require a 48" power jumper in the center
  - Data Port Plates are included

**SPECIFICATION OPTIONS**

**product #:** see charts below  
**worksurface finish:** see page 8  
**edge finish:** see page 8  
**finish:** see page 8

**ORDER EXAMPLE**

**product #:** FVSES.2448-E4  
**worksurface finish:** M1 Light Maple  
**edge finish:** E1 Light Maple  
**finish:** CW Cloud White

**4-CIRCUIT, 24" DEPTH**

PART #	HEIGHT	WIDTH	DEPTH	WT. (LBS)	LIST
FVSES.2448-E4	—	48"	25.5"		\$1,732
FVSES.2454-E4	—	54"	25.5"		\$1,803
FVSES.2460-E4	—	60"	25.5"		\$1,905
FVSES.2466-E4	—	66"	25.5"		\$1,992
FVSES.2472-E4	—	72"	25.5"		\$2,077
FVSES.2478-E4	—	78"	25.5"		\$2,164
FVSES.2484-E4	—	84"	25.5"		\$2,250
FVSES.2496-E4	—	96"	25.5"		\$3,290

**NOTES**

- Includes a 4-circuit power block
- Order 4-circuit power infeed, jumper, and duplexes separately

**4-CIRCUIT, 30" DEPTH**

PART #	HEIGHT	WIDTH	DEPTH	WT. (LBS)	LIST
FVSES.3048-E4	—	48"	31.5"		\$1,803
FVSES.3054-E4	—	54"	31.5"		\$1,882
FVSES.3060-E4	—	60"	31.5"		\$1,991
FVSES.3066-E4	—	66"	31.5"		\$2,047
FVSES.3072-E4	—	72"	31.5"		\$2,179
FVSES.3078-E4	—	78"	31.5"		\$2,273
FVSES.3084-E4	—	84"	31.5"		\$2,367
FVSES.3096-E4	—	96"	31.5"		\$3,517

**NOTES**

- Includes a 4-circuit power block
- Order 4-circuit power infeed, jumper, and duplexes separately

# Starter/End Element, Double-Sided NON-POWERED

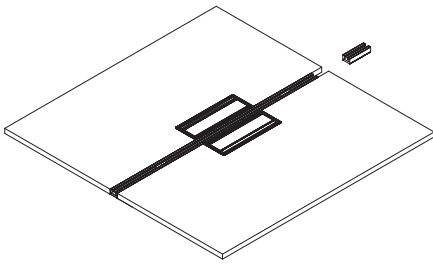

DESCRIPTION

Starter/End Elements are required at the start and end of every run.

Includes a support structure with wire management trough, and two worksurfaces with access grommet.

NOTES

- Starter/End Elements:
- Order another Starter/End Element (required) separately to complete run.
  - Order Extension Elements (optional) to expand a run.
  - Order supports separately (supporting legs, pedestals, cabinets, credenzas).
  - 96"W worksurfaces have two grommets.
  - 96" wide elements require a center support leg (ordered separately)

SPECIFICATION OPTIONS

**product #:** see charts below  
**worksurface finish:** see page 8  
**edge finish:** see page 8  
**finish:** see page 8  
**support selection:** CON1SD Concave or STRAIGHT LEG

ORDER EXAMPLE

**product #:** FVSED.4848-N  
**worksurface finish:** M1 Light Maple  
**edge finish:** E1 Light Maple  
**finish:** CW Cloud White  
**support selection:** CON1SD

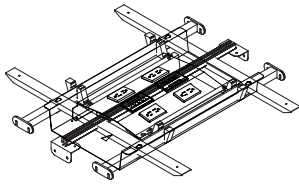

Support Structure

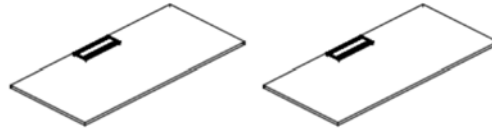

Worksurfaces (2)

**NON-POWERED, 48" DEPTH**

PART #	HEIGHT	WIDTH	DEPTH	WT. (LBS)	LIST
FVSED.4848-N	—	48"	49.5"		\$2,365
FVSED.4854-N	—	54"	49.5"		\$2,605
FVSED.4860-N	—	60"	49.5"		\$2,642
FVSED.4866-N	—	66"	49.5"		\$2,781
FVSED.4872-N	—	72"	49.5"		\$2,919
FVSED.4878-N	—	78"	49.5"		\$3,059
FVSED.4884-N	—	84"	49.5"		\$3,369
FVSED.4896-N	—	96"	49.5"		\$5,114

**NON-POWERED, 60" DEPTH**

PART #	HEIGHT	WIDTH	DEPTH	WT. (LBS)	LIST
FVSED.6048-N	—	48"	61.5"		\$2,504
FVSED.6054-N	—	54"	61.5"		\$2,626
FVSED.6060-N	—	60"	61.5"		\$2,811
FVSED.6066-N	—	66"	61.5"		\$2,891
FVSED.6072-N	—	72"	61.5"		\$3,121
FVSED.6078-N	—	78"	61.5"		\$3,275
FVSED.6084-N	—	84"	61.5"		\$3,431
FVSED.6096-N	—	96"	61.5"		\$6,024

# Starter/End Element, Double-Sided POWERED

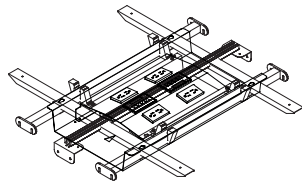
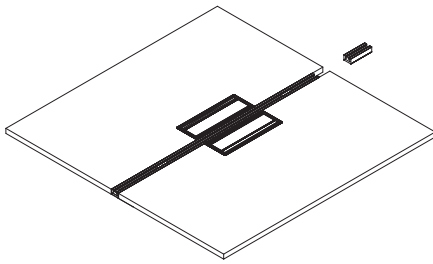

**Support Structure**

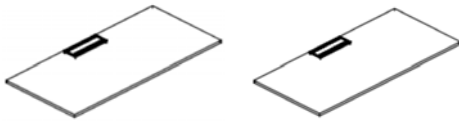

**Worksurfaces (2)**

**DESCRIPTION**

Starter/End Elements are required at the start and end of every run.

Includes a support structure with 4-circuit power block, wire management trough, and two worksurfaces with access grommet. Data Port Plates are included

**NOTES**

- Starter/End Elements:
- Order another Starter/End Element (required) separately to complete run.
  - Order Extension Elements (optional) to expand a run.
  - Order supports separately (supporting legs, pedestals, cabinets, credenzas).
  - 96" W worksurfaces have two grommets.
- Powered:
- Includes a 4-circuit power block.
  - Order 4-circuit power infeed, jumper, and duplexes separately.
  - Each grommet has 2 duplex locations
  - 96" wide elements require a center support leg (ordered separately)
  - 96" wide elements require a 48" power jumper in the center
  - Data Port Plates are included
  - If using Concave Support Leg, specify concave support selection.

**SPECIFICATION OPTIONS**

- product #:** see charts below
- worksurface finish:** see page 8
- edge finish:** see page 8
- finish:** see page 8
- support selection:** CON1SD Concave or STRAIGHT LEG

**ORDER EXAMPLE**

- product #:** FVSED.4848-E4
- worksurface finish:** M1 Light Maple
- edge finish:** E1 Light Maple
- finish:** CW Cloud White
- support selection:** CON1SD

**4-CIRCUIT, 48" DEPTH**

PART #	HEIGHT	WIDTH	DEPTH	WT. (LBS)	LIST
FVSED.4848-E4	—	48"	49.5"		\$2,630
FVSED.4854-E4	—	54"	49.5"		\$2,873
FVSED.4860-E4	—	60"	49.5"		\$2,907
FVSED.4866-E4	—	66"	49.5"		\$3,047
FVSED.4872-E4	—	72"	49.5"		\$3,186
FVSED.4878-E4	—	78"	49.5"		\$3,327
FVSED.4884-E4	—	84"	49.5"		\$3,635
FVSED.4896-E4	—	96"	49.5"		\$5,380

**NOTES**

- Includes a 4-circuit power block
- Order 4-circuit power infeed, jumper, and duplexes separately

**4-CIRCUIT, 60" DEPTH**

PART #	HEIGHT	WIDTH	DEPTH	WT. (LBS)	LIST
FVSED.6048-E4	—	48"	61.5"		\$2,771
FVSED.6054-E4	—	54"	61.5"		\$2,892
FVSED.6060-E4	—	60"	61.5"		\$3,078
FVSED.6066-E4	—	66"	61.5"		\$3,158
FVSED.6072-E4	—	72"	61.5"		\$3,387
FVSED.6078-E4	—	78"	61.5"		\$3,542
FVSED.6084-E4	—	84"	61.5"		\$3,697
FVSED.6096-E4	—	96"	61.5"		\$6,291

**NOTES**

- Includes a 4-circuit power block
- Order 4-circuit power infeed, jumper, and duplexes separately

## Starter/End Element, 120° 3 Pack NON-POWERED

### DESCRIPTION

Starter/End Elements are required at the start and end of every run.

### SPECIFICATION OPTIONS

**product #:** see charts below  
**worksurface finish:** see page 8  
**edge finish:** see page 8  
**finish:** see page 8  
**support selection:** CON2SD Concave or STRAIGHT LEG

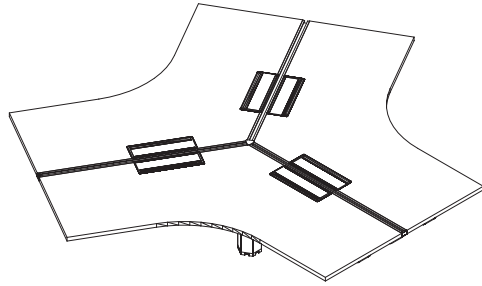

### NOTES

Starter/End Elements:

- Order another Starter/End Element (required) separately to complete run.
- Order Extension Elements (optional) to expand a run.
- Order supports separately (supporting legs, pedestals, cabinets, credenzas).

### ORDER EXAMPLE

**product #:** FVSE120.2436-N  
**worksurface finish:** M1 Light Maple  
**edge finish:** E1 Light Maple  
**finish:** CW Cloud White  
**support selection:** STRAIGHT LEG

STARTER/END ELEMENTS

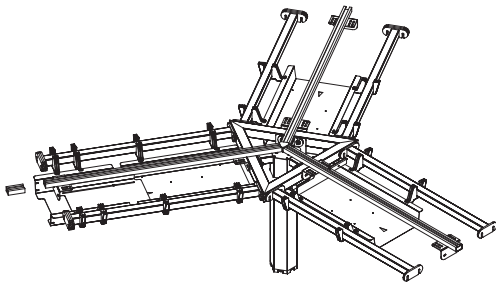

Support Structure

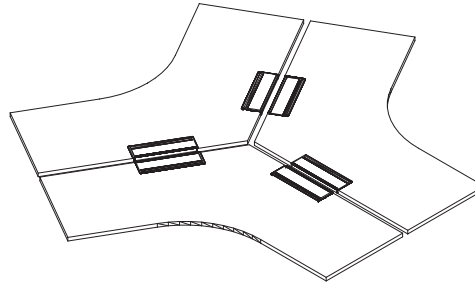

Worksurface

### NON-POWERED, 24" DEPTH

PART #	HEIGHT	WIDTH	DEPTH	WT. (LBS)	LIST
FVSE120.2436-N	—	36"	24"		\$5,858
FVSE120.2442-N	—	42"	24"		\$6,692
FVSE120.2448-N	—	48"	24"		\$7,482

### NOTES

- Includes a 4-circuit power block
- Order 4-circuit power infeed, jumper, and duplexes separately

# Starter/End Element, 120° 3 Pack

POWERED

DESCRIPTION

Starter/End Elements are required at the start and end of every run.

Includes a support structure with 4-circuit power block, wire management trough, and three worksurfaces with access grommet. Data Port Plates are included

SPECIFICATION OPTIONS

**product #:** see charts below  
**worksurface finish:** see page 8  
**edge finish:** see page 8  
**finish:** see page 8  
**support selection:** CON2SD Concave or STRAIGHT LEG

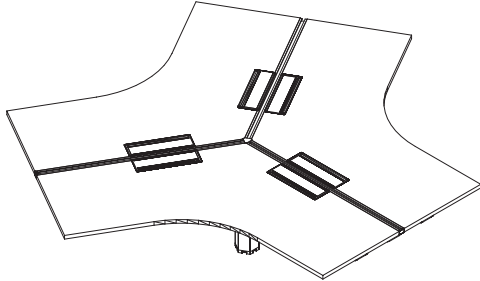

NOTES

- Starter/End Elements:
- Order another Starter/End Element (required) separately to complete run.
  - Order Extension Elements (optional) to expand a run.
  - Order supports separately (supporting legs, pedestals, cabinets, credenzas).

Powered:

- Includes a 4-circuit power block.
- Order 4-circuit power infeed and duplexes separately.
- To connect one Starter/End element to another element, order a jumper to connect element to element - pg 63
- Each grommet has 2 duplex locations
- Data Port Plates are included

ORDER EXAMPLE

**product #:** FVSE120.2436-E4  
**worksurface finish:** M1 Light Maple  
**edge finish:** E1 Light Maple  
**finish:** CW Cloud White  
**support selection:** STRAIGHT LEG

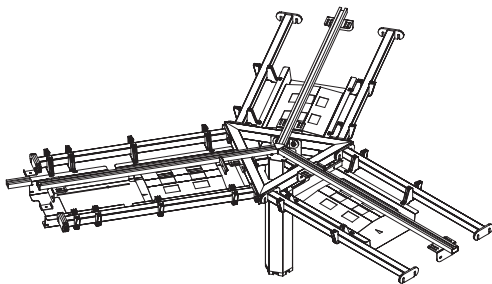

Support Structure

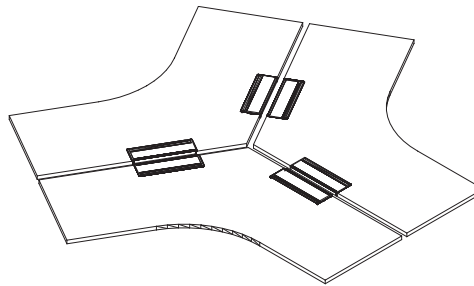

Worksurface

POWERED, 48" DEPTH

PART #	HEIGHT	WIDTH	DEPTH	WT. (LBS)	LIST
FVSE120.2436-E4	—	36"	49.5"		\$6,847
FVSE120.2442-E4	—	42"	49.5"		\$7,680
FVSE120.2448-E4	—	48"	49.5"		\$8,471

NOTES

- This part # includes (1) 4-circuit power block
- This part # includes (3) festoons, (2) jumpers
- To connect one Starter/End element to another element, order (1) 48" jumper
- Order 4-circuit power infeed and duplexes separately

## Extension Element, Single-Sided NON-POWERED

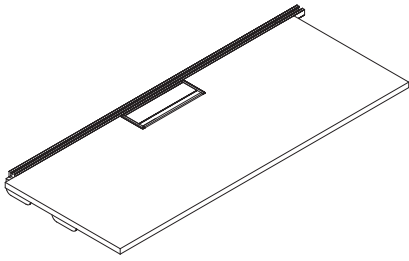

### DESCRIPTION

Extension Elements are used to expand a run between two Starter/End Elements.

Includes a support structure with wire management trough, and worksurface with access grommet.

### NOTES

Extension Elements:

- Order two Starter/End Elements (required) separately to complete a run.
- Order supports separately (supporting legs, pedestals, cabinets, credenzas).
- 96"W worksurfaces have two grommets.
- 96" wide elements require a center support leg (ordered separately)

### SPECIFICATION OPTIONS

**product #:** see charts below  
**worksurface finish:** see page 8  
**edge finish:** see page 8  
**finish:** see page 8

### ORDER EXAMPLE

**product #:** FVES.2448-N  
**worksurface finish:** M1 Light Maple  
**edge finish:** E1 Light Maple  
**finish:** CW Cloud White

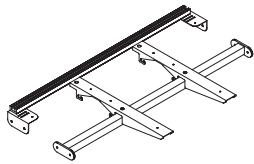

Support Structure

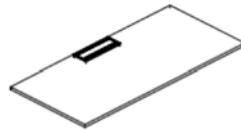

Worksurface

### NON-POWERED, 24" DEPTH

PART #	HEIGHT	WIDTH	DEPTH	WT. (LBS)	LIST
FVES.2448-N	—	48"	25.5"		\$1,777
FVES.2454-N	—	54"	25.5"		\$1,847
FVES.2460-N	—	60"	25.5"		\$1,950
FVES.2466-N	—	66"	25.5"		\$2,036
FVES.2472-N	—	72"	25.5"		\$2,121
FVES.2478-N	—	78"	25.5"		\$2,209
FVES.2484-N	—	84"	25.5"		\$2,293
FVES.2496-N	—	96"	25.5"		\$3,192

### NON-POWERED, 30" DEPTH

PART #	HEIGHT	WIDTH	DEPTH	WT. (LBS)	LIST
FVES.3048-N	—	48"	31.5"		\$1,847
FVES.3054-N	—	54"	31.5"		\$1,926
FVES.3060-N	—	60"	31.5"		\$2,033
FVES.3066-N	—	66"	31.5"		\$2,091
FVES.3072-N	—	72"	31.5"		\$2,223
FVES.3078-N	—	78"	31.5"		\$2,316
FVES.3084-N	—	84"	31.5"		\$2,411
FVES.3096-N	—	96"	31.5"		\$3,363

## Extension Element, Single-Sided POWERED

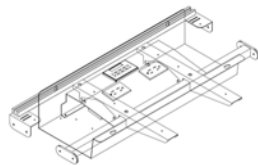
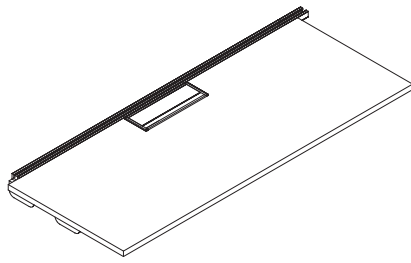

Support Structure

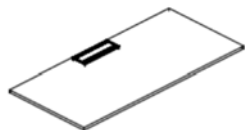

Worksurface

DESCRIPTION

Extension Elements are used to expand a run between two Starter/End Elements.

Includes a support structure with 4-circuit power block, wire management trough, and worksurface with access grommet. Data Port Plates are included

NOTES

- Extension Elements:
- Order two Starter/End Elements (required) separately to complete a run.
  - Order supports separately (supporting legs, pedestals, cabinets, credenzas).
  - 96" W worksurfaces have two grommets.
- Powered:
- Includes a 4-circuit power block.
  - Order 4-circuit power infeed, jumper, and duplexes separately.
  - Each grommet has 2 duplex locations
  - 96" wide elements require a center support leg (ordered separately)
  - 96" wide elements require a 48" power jumper in the center
  - Data Port Plates are included

SPECIFICATION OPTIONS

**product #:** see charts below  
**worksurface finish:** see page 8  
**edge finish:** see page 8  
**finish:** see page 8

ORDER EXAMPLE

**product #:** FVES.2448-E4  
**worksurface finish:** M1 Light Maple  
**edge finish:** E1 Light Maple  
**finish:** CW Cloud White

### 4-CIRCUIT, 24" DEPTH

PART #	HEIGHT	WIDTH	DEPTH	WT. (LBS)	LIST
FVES.2448-E4	—	48"	25.5"		\$1,888
FVES.2454-E4	—	54"	25.5"		\$1,958
FVES.2460-E4	—	60"	25.5"		\$2,060
FVES.2466-E4	—	66"	25.5"		\$2,146
FVES.2472-E4	—	72"	25.5"		\$2,232
FVES.2478-E4	—	78"	25.5"		\$2,319
FVES.2484-E4	—	84"	25.5"		\$2,405
FVES.2496-E4	—	96"	25.5"		\$3,516

NOTES

- Includes a 4-circuit power block
- Order 4-circuit power infeed, jumper, and duplexes separately

### 4-CIRCUIT, 30" DEPTH

PART #	HEIGHT	WIDTH	DEPTH	WT. (LBS)	LIST
FVES.3048-E4	—	48"	31.5"		\$1,958
FVES.3054-E4	—	54"	31.5"		\$2,036
FVES.3060-E4	—	60"	31.5"		\$2,145
FVES.3066-E4	—	66"	31.5"		\$2,201
FVES.3072-E4	—	72"	31.5"		\$2,332
FVES.3078-E4	—	78"	31.5"		\$2,427
FVES.3084-E4	—	84"	31.5"		\$2,522
FVES.3096-E4	—	96"	31.5"		\$3,686

NOTES

- Includes a 4-circuit power block
- Order 4-circuit power infeed, jumper, and duplexes separately

## Extension Element, Double-Sided NON-POWERED

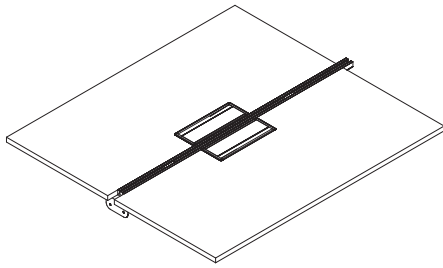

### DESCRIPTION

Extension Elements are used to expand a run between two Starter/End Elements.

Includes a support structure with wire management trough and two worksurfaces with access grommet.

### NOTES

Extension Elements:

- Order two Starter/End Elements (required) separately to complete a run.
- Order supports separately (supporting legs, pedestals, cabinets, credenzas).
- 96"W worksurfaces have two grommets.
- Order support legs separately.
- 96" wide elements require a center support leg (ordered separately)

### SPECIFICATION OPTIONS

**product #:** see charts below  
**worksurface finish:** see page 8  
**edge finish:** see page 8  
**finish:** see page 8

### ORDER EXAMPLE

**product #:** FVED.4848-N  
**worksurface finish:** M1 Light Maple  
**edge finish:** E1 Light Maple  
**finish:** CW Cloud White

EXTENSION ELEMENTS

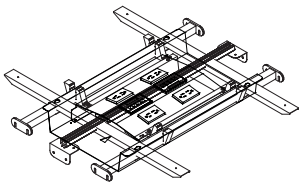

Support Structure

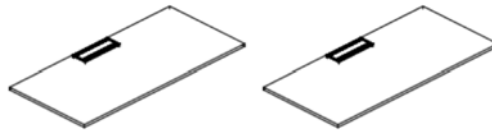

Worksurfaces (2)

### NON-POWERED, 48" DEPTH

PART #	HEIGHT	WIDTH	DEPTH	WT. (LBS)	LIST
FVED.4848-N	—	48"	49.5"		\$2,763
FVED.4854-N	—	54"	49.5"		\$2,872
FVED.4860-N	—	60"	49.5"		\$3,041
FVED.4866-N	—	66"	49.5"		\$3,179
FVED.4872-N	—	72"	49.5"		\$3,319
FVED.4878-N	—	78"	49.5"		\$3,458
FVED.4884-N	—	84"	49.5"		\$3,596
FVED.4896-N	—	96"	49.5"		\$7,098

### NON-POWERED, 60" DEPTH

PART #	HEIGHT	WIDTH	DEPTH	WT. (LBS)	LIST
FVED.6048-N	—	48"	61.5"		\$2,903
FVED.6054-N	—	54"	61.5"		\$3,024
FVED.6060-N	—	60"	61.5"		\$3,041
FVED.6066-N	—	66"	61.5"		\$3,290
FVED.6072-N	—	72"	61.5"		\$3,520
FVED.6078-N	—	78"	61.5"		\$3,675
FVED.6084-N	—	84"	61.5"		\$3,829
FVED.6096-N	—	96"	61.5"		\$7,628



# Extension Element, Double-Sided

## POWERED

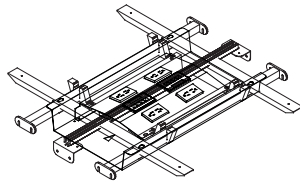
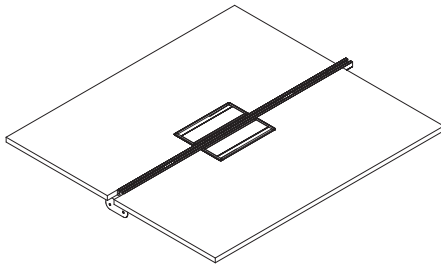

**Support Structure**

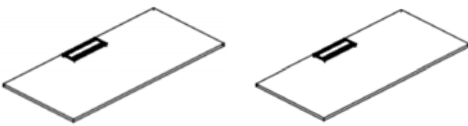

**Worksurfaces (2)**

**DESCRIPTION**

Extension Elements are used to expand a run between two Starter/End Elements.

Includes a support structure with 4-circuit power block, wire management trough, and two worksurfaces with access grommet. Data Port Plates are included

**NOTES**

- Extension Elements:
- Order two Starter/End Elements (required) separately to complete a run.
  - Order supports separately (supporting legs, pedestals, cabinets, credenzas).
  - 96" W worksurfaces have two grommets.
- Powered:
- Includes a 4-circuit power block.
  - Order 4-circuit power infeed, jumper and duplexes separately.
  - Each grommet has 2 duplex locations
  - Order support legs separately.
  - 96" wide elements require a center support leg (ordered separately)
  - 96" wide elements require a 48" power jumper in the center
  - Data Port Plates are included

**SPECIFICATION OPTIONS**

**product #:** see charts below  
**worksurface finish:** see page 8  
**edge finish:** see page 8  
**finish:** see page 8

**ORDER EXAMPLE**

**product #:** FVED.4848-E4  
**worksurface finish:** M1 Light Maple  
**edge finish:** E1 Light Maple  
**finish:** CW Cloud White

**4-CIRCUIT, 48" DEPTH**

PART #	HEIGHT	WIDTH	DEPTH	WT. (LBS)	LIST
FVED.4848-E4	—	48"	49.5"		\$3,030
FVED.4854-E4	—	54"	49.5"		\$3,137
FVED.4860-E4	—	60"	49.5"		\$3,307
FVED.4866-E4	—	66"	49.5"		\$3,447
FVED.4872-E4	—	72"	49.5"		\$3,587
FVED.4878-E4	—	78"	49.5"		\$3,725
FVED.4884-E4	—	84"	49.5"		\$3,864
FVED.4896-E4	—	96"	49.5"		\$7,365

**NOTES**

- Includes a 4-circuit power block
- Order 4-circuit power infeed, jumper, and duplexes separately

**4-CIRCUIT, 60" DEPTH**

PART #	HEIGHT	WIDTH	DEPTH	WT. (LBS)	LIST
FVED.6048-E4	—	48"	61.5"		\$3,171
FVED.6054-E4	—	54"	61.5"		\$3,292
FVED.6060-E4	—	60"	61.5"		\$3,307
FVED.6066-E4	—	66"	61.5"		\$3,557
FVED.6072-E4	—	72"	61.5"		\$3,788
FVED.6078-E4	—	78"	61.5"		\$3,942
FVED.6084-E4	—	84"	61.5"		\$4,096
FVED.6096-E4	—	96"	61.5"		\$7,893

**NOTES**

- Includes a 4-circuit power block
- Order 4-circuit power infeed, jumper, and duplexes separately

## Extension Element, 120° 3 Pack NON-POWERED

### DESCRIPTION

Starter/End Elements are required at the start and end of every run.

### SPECIFICATION OPTIONS

**product #:** see charts below  
**worksurface finish:** see page 8  
**edge finish:** see page 8  
**finish:** see page 8

### NOTES

Starter/End Elements:

- Order another Starter/End Element (required) separately to complete run.
- Order Extension Elements (optional) to expand a run.
- Order supports separately (supporting legs, pedestals, cabinets, credenzas).

### ORDER EXAMPLE

**product #:** FVE120.2436-N  
**worksurface finish:** M1 Light Maple  
**edge finish:** E1 Light Maple  
**finish:** CW Cloud White

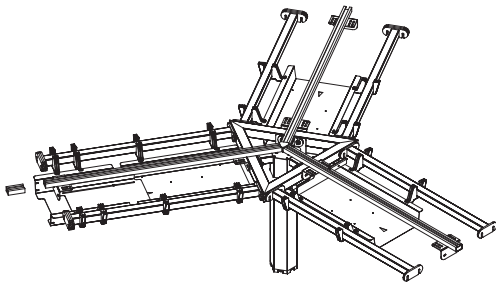
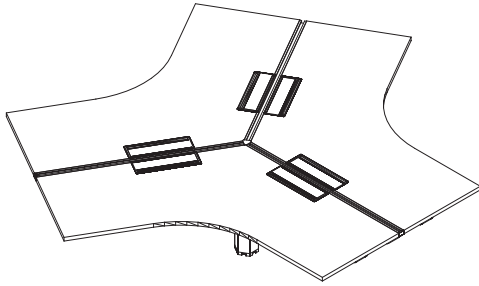

Support Structure

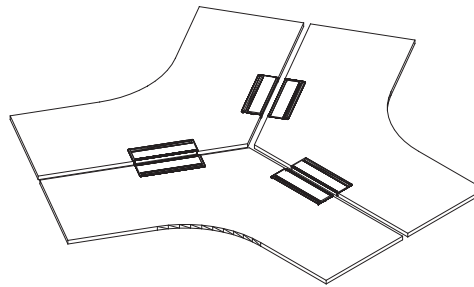

Worksurface

### NON-POWERED, 24" DEPTH

PART #	HEIGHT	WIDTH	DEPTH	WT. (LBS)	LIST
FVE120.2436-N	—	36"	24"		\$6,048
FVE120.2442-N	—	42"	24"		\$6,882
FVE120.2448-N	—	48"	24"		\$7,757

### NOTES

- Includes a 4-circuit power block
- Order 4-circuit power infeed, jumper, and duplexes separately

# Extension Element, 120° 3 Pack POWERED

DESCRIPTION

Extension Elements are used to expand a run between two Starter/End Elements.

Includes a support structure with wire management trough, and (3) worksurfaces with access grommets. Data Port Plates are included

NOTES

- Extension Elements:
- Order two Starter/End Elements (required) separately to complete a run.
  - Order supports separately (supporting legs, pedestals, cabinets, credenzas).
- Powered:
- Includes a 4-circuit power block.
  - Order 4-circuit power infeed, jumper, and duplexes separately.
  - Each grommet has 2 duplex locations
  - Data Port Plates are included

SPECIFICATION OPTIONS

**product #:** see charts below  
**worksurface finish:** see page 8  
**edge finish:** see page 8  
**finish:** see page 8

ORDER EXAMPLE

**product #:** FVE120.2436-E4  
**worksurface finish:** M1 Light Maple  
**edge finish:** E1 Light Maple  
**finish:** CW Cloud White

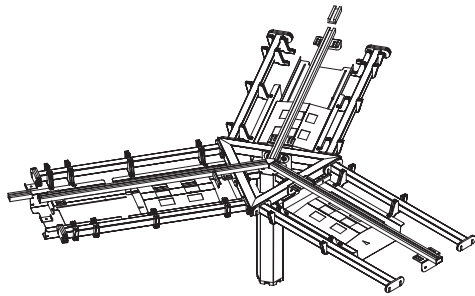
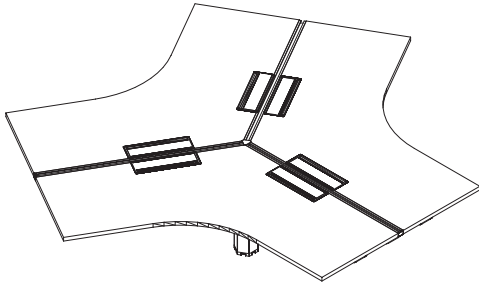

Support Structure

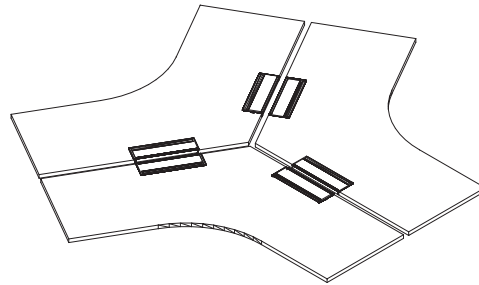

Worksurface

POWERED, 24" DEPTH

PART #	HEIGHT	WIDTH	DEPTH	WT. (LBS)	LIST
FVE120.2436-E4	—	36"	25.5"		\$7,034
FVE120.2442-E4	—	42"	25.5"		\$7,870
FVE120.2448-E4	—	48"	25.5"		\$8,745

## Stand-Alone Element, Single-Sided NON-POWERED

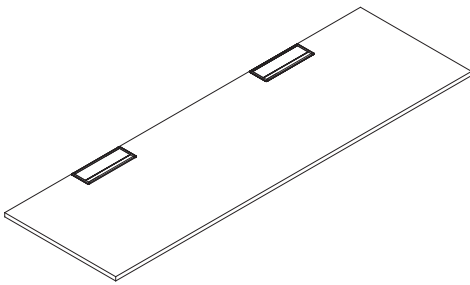

DESCRIPTION

Stand-Alone Elements require support legs. They should not connect to a Start/End Element or Extension Element.

Includes a support structure with wire management trough, and worksurfaces with (2) access grommets.

NOTES

- Stand-Alone Elements:
- Order support legs separately
  - 96"W worksurfaces have two grommets.
  - 96" worksurfaces require a center support. Order separately.

SPECIFICATION OPTIONS

**product #:** see charts below  
**worksurface finish:** see page 8  
**edge finish:** see page 8  
**finish:** see page 8

ORDER EXAMPLE

**product #:** FVSAES.2496-N  
**worksurface finish:** M1 Light Maple  
**edge finish:** E1 Light Maple  
**finish:** CW Cloud White

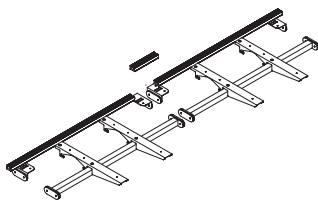

Support Structure

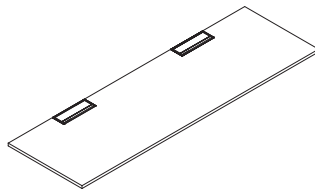

Worksurface

**NON-POWERED, 24" DEPTH**

PART #	HEIGHT	WIDTH	DEPTH	WT. (LBS)	LIST
FVSAES.2496-N	—	96"	25.5"		\$3,192

**NON-POWERED, 30" DEPTH**

PART #	HEIGHT	WIDTH	DEPTH	WT. (LBS)	LIST
FVSAES.3096-N	—	96"	31.5"		\$3,363

# Stand-Alone Element, Single-Sided

## NON-POWERED

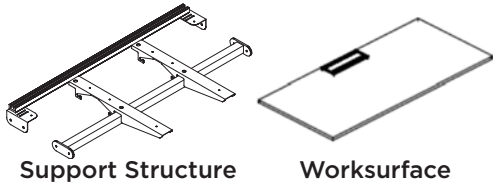
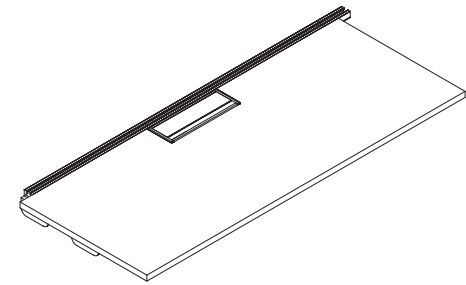

Support Structure

Worksurface

DESCRIPTION

Stand-Alone Elements require support legs. They should not connect to a Start/End Element or Extension Element.

Includes a support structure with wire management trough, and one worksurface with (2) access grommets.

NOTES

- Stand-Alone Elements:
- Order support legs separately

SPECIFICATION OPTIONS

**product #:** see charts below  
**worksurface finish:** see page 8  
**edge finish:** see page 8  
**finish:** see page 8

ORDER EXAMPLE

**product #:** FVSAES.2448-N  
**worksurface finish:** M1 Light Maple  
**edge finish:** E1 Light Maple  
**finish:** CW Cloud White

### 24" DEPTH

PART #	HEIGHT	WIDTH	DEPTH	WT. (LBS)	LIST
FVSAES.2448-N	—	48"	25.5"		\$1,558
FVSAES.2450-N	—	50"	25.5"		\$1,589
FVSAES.2454-N	—	54"	25.5"		\$1,622
FVSAES.2460-N	—	60"	25.5"		\$1,729
FVSAES.2462-N	—	62"	25.5"		\$1,772
FVSAES.2466-N	—	66"	25.5"		\$1,816
FVSAES.2472-N	—	72"	25.5"		\$1,901
FVSAES.2478-N	—	78"	25.5"		\$1,986
FVSAES.2484-N	—	84"	25.5"		\$2,074

### 30" DEPTH

PART #	HEIGHT	WIDTH	DEPTH	WT. (LBS)	LIST
FVSAES.3048-N	—	48"	31.5"		\$1,628
FVSAES.3050-N	—	50"	31.5"		\$1,665
FVSAES.3054-N	—	54"	31.5"		\$1,705
FVSAES.3060-N	—	60"	31.5"		\$1,814
FVSAES.3062-N	—	62"	31.5"		\$1,842
FVSAES.3066-N	—	66"	31.5"		\$1,870
FVSAES.3072-N	—	72"	31.5"		\$2,002
FVSAES.3078-N	—	78"	31.5"		\$2,096
FVSAES.3084-N	—	84"	31.5"		\$2,190

## Stand-Alone Element, Single-Sided POWERED

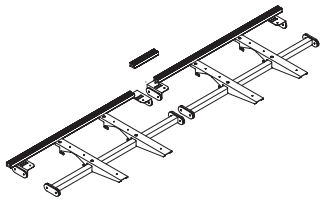
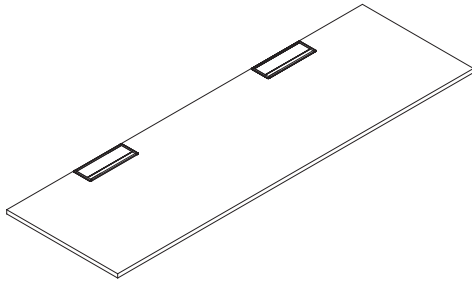

**Support Structure**

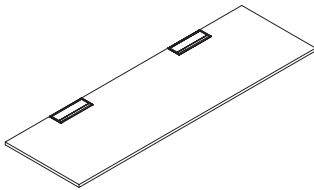

**Worksurface**

DESCRIPTION

Stand-Alone Elements require support legs. They should not connect to a Start/End Element or Extension Element.

Includes a support structure with 4-circuit power block, wire management trough, and one worksurface with (2) access grommets. Data Port Plates are included

NOTES

Stand-Alone Elements:

- Order support legs separately
- 96" W worksurfaces have two grommets
- 96" worksurfaces require a center support. Order separately

Powered:

- Includes a 4-circuit power block
- Order 4-circuit power infeed and duplexes separately
- Each grommet has 2 duplex locations
- Order support legs separately
- 96" wide elements require a center support leg (ordered separately)
- 96" wide elements require a 48" power jumper in the center (order separately)
- Data Port Plates are included

SPECIFICATION OPTIONS

**product #:** see charts below  
**worksurface finish:** see page 8  
**edge finish:** see page 8  
**finish:** see page 8

ORDER EXAMPLE

**product #:** FVSAES.2496-E4  
**worksurface finish:** M1 Light Maple  
**edge finish:** E1 Light Maple  
**finish:** CW Cloud White

**4-CIRCUIT, 24" DEPTH**

PART #	HEIGHT	WIDTH	DEPTH	WT. (LBS)	LIST
FVSAES.2496-E4	—	96"	25.5"		\$3,516

NOTES

- Includes a 4-circuit power block
- Order 4-circuit power infeed and duplexes separately

**4-CIRCUIT, 30" DEPTH**

PART #	HEIGHT	WIDTH	DEPTH	WT. (LBS)	LIST
FVSAES.3096-E4	—	96"	31.5"		\$3,686

NOTES

- Includes a 4-circuit power block
- Order 4-circuit power infeed and duplexes separately

# Stand-Alone Element, Single-Sided POWERED

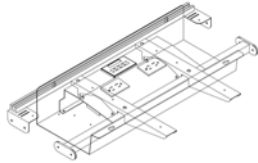
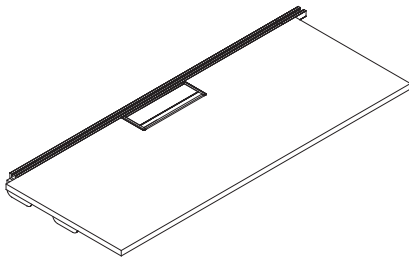

**Support Structure**

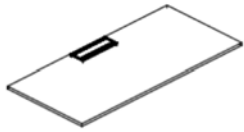

**Worksurface**

**DESCRIPTION**

Stand-Alone Elements require support legs. They should not connect to a Start/End Element or Extension Element.

Includes a support structure with 4-circuit power block, wire management trough, and one worksurface with (2) access grommets. Data Port Plates are included

**NOTES**

Stand-Alone Elements:

- Order support legs separately

Powered:

- Includes a 4-circuit power block
- Order 4-circuit power infeed and duplexes separately
- Each grommet has 2 duplex locations
- Order support legs separately
- Data Port Plates are included

**SPECIFICATION OPTIONS**

**product #:** see charts below  
**worksurface finish:** see page 8  
**edge finish:** see page 8  
**finish:** see page 8

**ORDER EXAMPLE**

**product #:** FVSAES.2448-E4  
**worksurface finish:** M1 Light Maple  
**edge finish:** E1 Light Maple  
**finish:** CW Cloud White

**4-CIRCUIT, 24" DEPTH**

PART #	HEIGHT	WIDTH	DEPTH	WT. (LBS)	LIST
FVSAES.2448-E4	—	48"	25.5"		\$1,628
FVSAES.2450-E4	—	50"	25.5"		\$1,659
FVSAES.2454-E4	—	54"	25.5"		\$1,692
FVSAES.2460-E4	—	60"	25.5"		\$1,799
FVSAES.2462-E4	—	62"	25.5"		\$1,878
FVSAES.2466-E4	—	66"	25.5"		\$1,886
FVSAES.2472-E4	—	72"	25.5"		\$1,972
FVSAES.2478-E4	—	78"	25.5"		\$2,056
FVSAES.2484-E4	—	84"	25.5"		\$2,144

**NOTES**

- Includes a 4-circuit power block
- Order 4-circuit power infeed and duplexes separately

**4-CIRCUIT, 30" DEPTH**

PART #	HEIGHT	WIDTH	DEPTH	WT. (LBS)	LIST
FVSAES.3048-E4	—	48"	31.5"		\$1,698
FVSAES.3050-E4	—	50"	31.5"		\$1,737
FVSAES.3054-E4	—	54"	31.5"		\$1,775
FVSAES.3060-E4	—	60"	31.5"		\$1,884
FVSAES.3062-E4	—	62"	31.5"		\$1,912
FVSAES.3066-E4	—	66"	31.5"		\$1,940
FVSAES.3072-E4	—	72"	31.5"		\$2,072
FVSAES.3078-E4	—	78"	31.5"		\$2,166
FVSAES.3084-E4	—	84"	31.5"		\$2,260

**NOTES**

- Includes a 4-circuit power block
- Order 4-circuit power infeed and duplexes separately

## Stand-Alone Element, Double-Sided NON-POWERED

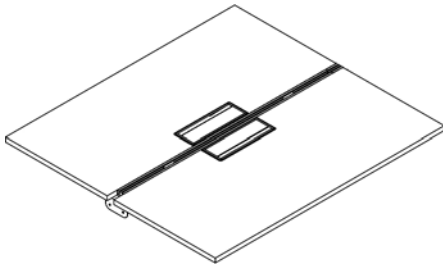

### DESCRIPTION

Stand-Alone Elements require supports. They should not connect to a Start/End Element or Extension Element.

Includes a support structure with wire management trough, and two worksurfaces with access grommet.

### NOTES

Stand-Alone Elements:

- Order supports separately (supporting legs, pedestals, cabinets, credenzas).
- 96"W worksurfaces have two grommets.
- 96" worksurfaces require a center support. Order separately.
- 96" wide elements require a center support leg (ordered separately)

### SPECIFICATION OPTIONS

**product #:** see charts below  
**worksurface finish:** see page 8  
**edge finish:** see page 8  
**finish:** see page 8  
**support selection:** CONISD Concave or CON2SD Concave or STRAIGHT LEG

### ORDER EXAMPLE

**product #:** FVSAED.4848-N  
**worksurface finish:** M1 Light Maple  
**edge finish:** E1 Light Maple  
**finish:** CW Cloud White  
**support selection:** CON2SD

STAND-ALONE ELEMENTS

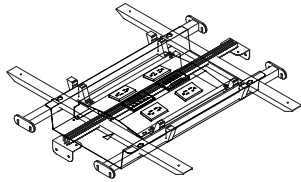

Support Structure

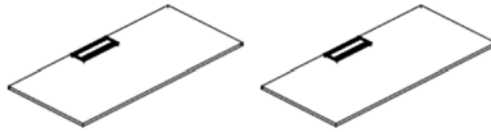

Worksurfaces (2)

### NON-POWERED, 48" DEPTH

PART #	HEIGHT	WIDTH	DEPTH	WT. (LBS)	LIST
FVSAED.4848-N	—	48"	49.5"		\$2,107
FVSAED.4854-N	—	54"	49.5"		\$2,210
FVSAED.4860-N	—	60"	49.5"		\$2,384
FVSAED.4866-N	—	66"	49.5"		\$2,522
FVSAED.4872-N	—	72"	49.5"		\$2,660
FVSAED.4878-N	—	78"	49.5"		\$2,799
FVSAED.4884-N	—	84"	49.5"		\$2,937
FVSAED.4896-N	—	96"	49.5"		\$4,682

### NON-POWERED, 60" DEPTH

PART #	HEIGHT	WIDTH	DEPTH	WT. (LBS)	LIST
FVSAED.6048-N	—	48"	61.5"		\$2,247
FVSAED.6054-N	—	54"	61.5"		\$2,368
FVSAED.6060-N	—	60"	61.5"		\$2,552
FVSAED.6066-N	—	66"	61.5"		\$2,631
FVSAED.6072-N	—	72"	61.5"		\$2,861
FVSAED.6078-N	—	78"	61.5"		\$3,016
FVSAED.6084-N	—	84"	61.5"		\$3,168
FVSAED.6096-N	—	96"	61.5"		\$5,592



# Stand-Alone Element, Double-Sided POWERED

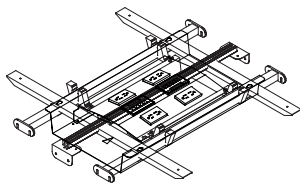
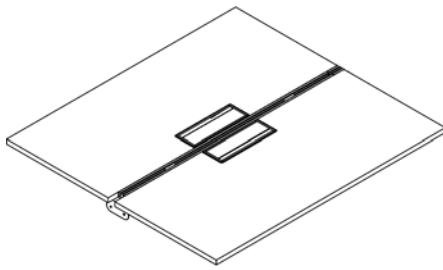

**Support Structure**

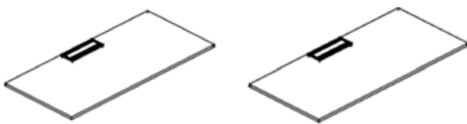

**Worksurfaces (2)**

**DESCRIPTION**

Stand-Alone Elements require supports. They should not connect to a Start/End Element or Extension Element.

Includes a support structure with 4-circuit power block, wire management trough, and two worksurfaces with access grommet. Data Port Plates are included

**NOTES**

- Stand-Alone Elements:
- Order supports separately (supporting legs, pedestals, cabinets, credenzas).
  - 96" W worksurfaces have two grommets.
  - 96" worksurfaces require a center support. Order separately.
- Powered:
- Includes a 4-circuit power block.
  - Order 4-circuit power infeed, jumper and duplexes separately
  - Each grommet has 2 duplex locations
  - Order support legs separately.
  - 96" wide elements require a center support leg (ordered separately)
  - 96" wide elements require a 48" power jumper in the center
  - Data Port Plates are included

**SPECIFICATION OPTIONS**

**product #:** see charts below  
**worksurface finish:** see page 8  
**edge finish:** see page 8  
**finish:** see page 8  
**support selection:** CON1SD Concave or CON2SD Concave or STRAIGHT LEG

**ORDER EXAMPLE**

**product #:** FVSAED.4848-E4  
**worksurface finish:** M1 Light Maple  
**edge finish:** E1 Light Maple  
**finish:** CW Cloud White  
**support selection:** CON2SD

**4-CIRCUIT, 48" DEPTH**

PART #	HEIGHT	WIDTH	DEPTH	WT. (LBS)	LIST
FVSAED.4848-E4	—	48"	49.5"		\$2,373
FVSAED.4854-E4	—	54"	49.5"		\$2,476
FVSAED.4860-E4	—	60"	49.5"		\$2,651
FVSAED.4866-E4	—	66"	49.5"		\$2,788
FVSAED.4872-E4	—	72"	49.5"		\$2,888
FVSAED.4878-E4	—	78"	49.5"		\$3,066
FVSAED.4884-E4	—	84"	49.5"		\$3,203
FVSAED.4896-E4	—	96"	49.5"		\$4,948

**NOTES**

- Includes a 4-circuit power block
- Order 4-circuit power infeed, jumper, and duplexes separately

**4-CIRCUIT, 60" DEPTH**

PART #	HEIGHT	WIDTH	DEPTH	WT. (LBS)	LIST
FVSAED.6048-E4	—	48"	61.5"		\$2,513
FVSAED.6054-E4	—	54"	61.5"		\$2,635
FVSAED.6060-E4	—	60"	61.5"		\$2,820
FVSAED.6066-E4	—	66"	61.5"		\$2,900
FVSAED.6072-E4	—	72"	61.5"		\$3,128
FVSAED.6078-E4	—	78"	61.5"		\$3,282
FVSAED.6084-E4	—	84"	61.5"		\$3,435
FVSAED.6096-E4	—	96"	61.5"		\$5,858

**NOTES**

- Includes a 4-circuit power block
- Order 4-circuit power infeed, jumper, and duplexes separately

## Stand-Alone Element, 120° 3 Pack NON-POWERED

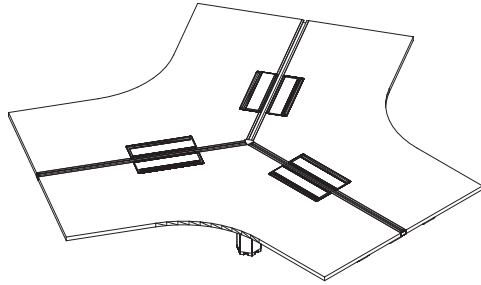

### DESCRIPTION

Stand-Alone Elements require supports. They should not connect to a Start/End Element or Extension Element.

Includes a support structure wire management trough, and (3) worksurfaces with access grommets.

### NOTES

- Cannot be part of a longer run. Can be placed next to units built with Elements.
- Order legs separately.
- Wire management troughs connect unit alone, do not connect to adjacent elements.

### SPECIFICATION OPTIONS

**product #:** see charts below  
**worksurface finish:** see page 8  
**edge finish:** see page 8  
**finish:** see page 8  
**support selection:** CON2SD Concave or CON3SD Concave or STRAIGHT LEG

### ORDER EXAMPLE

**product #:** FVSA120.2436-N  
**worksurface finish:** M1 Light Maple  
**edge finish:** E1 Light Maple  
**finish:** CW Cloud White  
**support selection:** STRAIGHT LEG

STAND-ALONE ELEMENTS

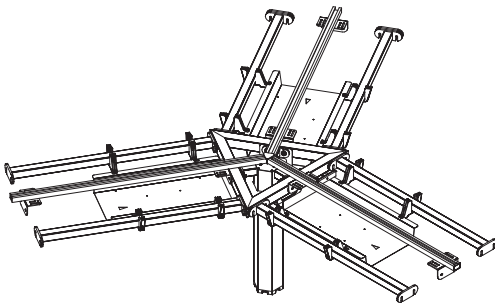

Support Structure

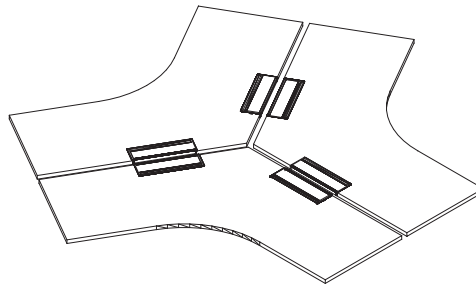

Worksurface

### NON-POWERED, 24" DEPTH

PART #	HEIGHT	WIDTH	DEPTH	WT. (LBS)	LIST
FVSAE120.2436-N	—	36"	24"		\$5,444
FVSAE120.2442-N	—	42"	24"		\$6,503
FVSAE120.2448-N	—	48"	24"		\$7,206

## Stand-Alone Element, 120° 3 Pack

POWERED

### DESCRIPTION

Stand-Alone Elements require supports. They should not connect to a Start/End Element or Extension Element.

Includes a support structure wire management trough, and (3) worksurfaces with access grommets.

Jumpers for each top  
Data Port Plates are included

### NOTES

- Cannot be part of a longer run. Can be placed next to units built with Elements.
- Order legs separately
- Wire management troughs connect unit alone, do not connect to adjacent elements.

### Powered:

- Includes a 4-circuit power block.
- Order 4-circuit power infeed, and duplexes separately.
- Each grommet has 2 duplex locations
- Data Port Plates are included

### SPECIFICATION OPTIONS

**product #:** see charts below  
**worksurface finish:** see page 8  
**edge finish:** see page 8  
**finish:** see page 8  
**support selection:** CON2SD Concave or CON3SD Concave or STRAIGHT LEG

### ORDER EXAMPLE

**product #:** FVSAE120.2436-E4  
**worksurface finish:** M1 Light Maple  
**edge finish:** E1 Light Maple  
**finish:** CW Cloud White  
**support selection:** STRAIGHT LEG

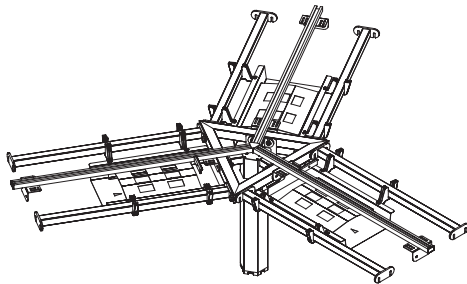
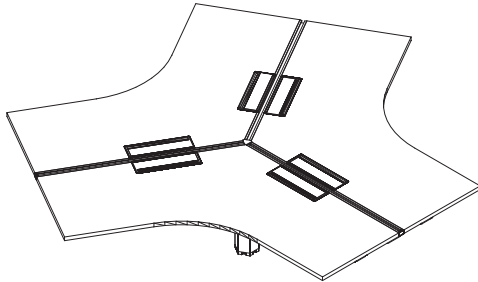

Support Structure

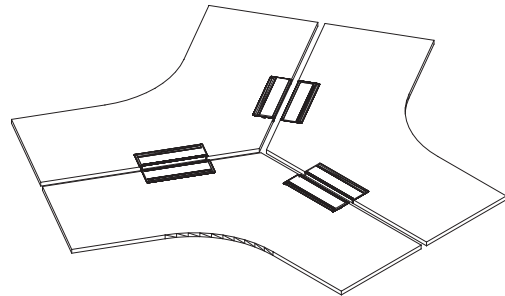

Worksurface

STAND-ALONE ELEMENTS

### POWERED, 24" DEPTH

PART #	HEIGHT	WIDTH	DEPTH	WT. (LBS)	LIST
FVSAE120.2436-E4	—	36"	24"		\$6,658
FVSAE120.2442-E4	—	42"	24"		\$7,492
FVSAE120.2448-E4	—	48"	24"		\$8,195

## Worksurface Supports, Single-Sided

FOR START/END OF RUN

DESCRIPTION	SPECIFICATION OPTIONS
Worksurface supports for single-sided Starter/End Elements.	<b>product #:</b> see charts below <b>finish:</b> see page 8 <b>left or right (if applicable):</b> L for Left, R for Right
NOTES	ORDER EXAMPLE
<ul style="list-style-type: none"> <li>Specify paint finish.</li> <li>Specify the correct size for unit.</li> </ul>	<b>product #:</b> FVTLS.24 <b>finish:</b> CW Cloud White <b>left or right (if applicable):</b> L for Left

### TRIANGLE LEG SINGLE-SIDED 25.5" WIDE

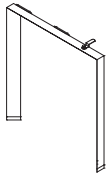

PART #	HEIGHT	WIDTH	DEPTH	WT. (LBS)	LIST	NOTES
FVTLS.24L	—	25.5"	—	—	\$234	For single-sided 24" deep units.
FVTLS.24R	—	25.5"	—	—	\$234	For use at the start or end of a run only. Specify L for Left and R for Right.

### TRIANGLE LEG SINGLE-SIDED 31.5" WIDE

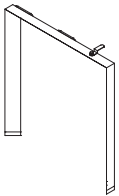

PART #	HEIGHT	WIDTH	DEPTH	WT. (LBS)	LIST	NOTES
FVTLS.30L	—	31.5"	—	—	\$251	For single-sided 30" deep units.
FVTLS.30R	—	31.5"	—	—	\$251	For use at the start or end of a run only. Specify L for Left and R for Right.

### TRAPEZOID LEG SINGLE-SIDED 25.5" WIDE

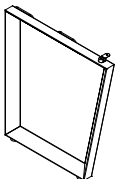

PART #	HEIGHT	WIDTH	DEPTH	WT. (LBS)	LIST	NOTES
FVTZLS.24L	—	25.5"	—	—	\$315	For single-sided 24" deep units.
FVTZLS.24R	—	25.5"	—	—	\$315	For use at the start or end of a run only. Specify L for Left and R for Right.

### TRAPEZOID LEG SINGLE-SIDED 31.5" WIDE

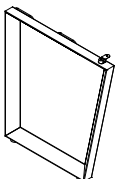

PART #	HEIGHT	WIDTH	DEPTH	WT. (LBS)	LIST	NOTES
FVTZLS.30L	—	25.5"	—	—	\$345	For single-sided 30" deep units.
FVTZLS.30R	—	25.5"	—	—	\$345	For use at the start or end of a run only. Specify L for Left and R for Right.

WORKSURFACE SUPPORTS

## Worksurface Supports, Single-Sided

FOR START/END OF A RUN continued

### TAPER LEG SINGLE-SIDED 24"/30"



PART #	HEIGHT	WIDTH	DEPTH	WT. (LBS)	LIST
FVATPS.24L	—	24"	—	—	\$683
FVATPS.24R	—	24"	—	—	\$683
FVATPS.30L	—	30"	—	—	\$691
FVATPS.30R	—	30"	—	—	\$691

### INSET LEG SINGLE-SIDED 24"/30"

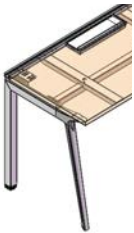

PART #	HEIGHT	WIDTH	DEPTH	WT. (LBS)	LIST
FVAINS.24L	—	24"	—	—	\$614
FVAINS.24R	—	24"	—	—	\$614
FVAINS.30L	—	30"	—	—	\$624
FVAINS.30R	—	30"	—	—	\$624

# Worksurface Supports, Single-Sided

## FOR CENTER OF A RUN

### DESCRIPTION

Worksurface supports for single-sided Extension Elements.

### SPECIFICATION OPTIONS

**product #:** see charts below  
**finish:** CW Cloud White

### NOTES

- Not for use with Stand Alone Elements.
- Specify paint finish.
- Specify the correct size for unit.

### ORDER EXAMPLE

**product #:** FVCLS-O  
**finish:** CW Cloud White

### OPEN CENTER LEG SINGLE-SIDED 24"/30" DEEP UNIT

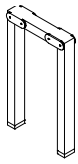

PART #	HEIGHT	WIDTH	DEPTH	WT. (LBS)	LIST
FVCLS-O	—	—	—	—	\$343

### NOTES

- For single-sided 24" or 30" deep units.
- For use at the center of a run only.
- Leg style is open.

### ENCLOSED CENTER LEG SINGLE-SIDED 24"/30" DEEP UNIT

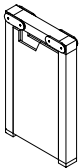

PART #	HEIGHT	WIDTH	DEPTH	WT. (LBS)	LIST
FVCLS-C	—	—	—	—	\$669

### NOTES

- For single-sided 24" or 30" deep units.
- For use at the center of a run only.
- Leg style is enclosed.

### TAPER LEG SINGLE-SIDED 24"/30"



PART #	HEIGHT	WIDTH	DEPTH	WT. (LBS)	LIST
FVCATPS.24	—	24"	—	—	\$718
FVCATPS.30	—	30"	—	—	\$726

### NOTES

- For single-sided 24" or 30" deep units.
- For use at the center of a run only.
- Leg style is open.

### INSET LEG SINGLE-SIDED 24"/30"



PART #	HEIGHT	WIDTH	DEPTH	WT. (LBS)	LIST
FVCAINS.24	—	24"	—	—	\$650
FVCAINS.30	—	30"	—	—	\$660

### NOTES

- For single-sided 24" or 30" deep units.
- For use at the center of a run only.
- Leg style is open.

The products listed in this pricer are manufactured by Friant & Associates, LLC. Any reference or similarity to the products of an original equipment manufacturer (O.E.M.) is not an expression of their approval or authorization.

## Worksurface Supports, Double-Sided

FOR START/END OF A RUN

DESCRIPTION

Worksurface supports for double-sided Starter/End Elements or stand alone elements

NOTES

- Specify paint finish.
- Specify the correct size for unit.

SPECIFICATION OPTIONS

**product #:** see charts below  
**finish:** see page 6

ORDER EXAMPLE

**product #:** FVTLD.48  
**finish:** CW Cloud White

### TRIANGLE LEG DOUBLE-SIDED 49.5" WIDE

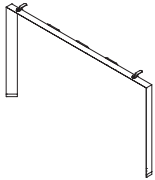

PART #	HEIGHT	WIDTH	DEPTH	WT. (LBS)	LIST
FVTLD.48	—	49.5"	—	—	\$312

- NOTES
- Worksurface support leg for double-sided structure.
  - For double-sided 24" deep units.
  - For use at the start or end of a run only or stand alone elements.
  - Use with straight support beam

### TRIANGLE LEG DOUBLE-SIDED 61.5" WIDE

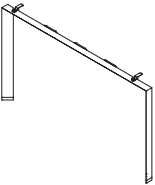

PART #	HEIGHT	WIDTH	DEPTH	WT. (LBS)	LIST
FVTLD.60	—	61.5"	—	—	\$336

- NOTES
- Worksurface support leg for double-sided structure.
  - For double-sided 30" deep units.
  - For use at the start or end of a run only or stand alone elements.
  - Use with straight support beam

### TRAPEZOID LEG DOUBLE-SIDED 49.5" WIDE

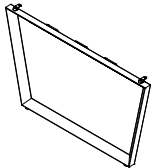

PART #	HEIGHT	WIDTH	DEPTH	WT. (LBS)	LIST
FVTZLD.48	—	49.5"	—	—	\$480

- NOTES
- Worksurface support leg for double-sided structure.
  - For double-sided 24" deep units.
  - For use at the start or end of a run only or stand alone elements.
  - Use with straight support beam

### TRAPEZOID LEG DOUBLE-SIDED 61.5" WIDE

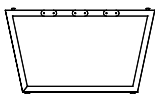

PART #	HEIGHT	WIDTH	DEPTH	WT. (LBS)	LIST
FVTZLD.60	—	61.5"	—	—	\$480

- NOTES
- Worksurface support leg for double-sided structure.
  - For double-sided 30" deep units.
  - For use at the start or end of a run only or stand alone elements.
  - Use with straight support beam

### WORKSURFACE ATTACHMENT BRACKET PAIR

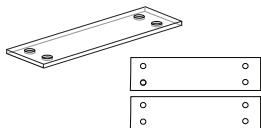

PART #	HEIGHT	WIDTH	DEPTH	WT. (LBS)	LIST
FVFB.08	—	8"	2"	—	\$38

- NOTES
- Worksurface brackets that attach a single-sided Stand Alone Element at the end of a double-sided run.
  - Finish on the bracket pair is BU Burnt Umber.

## Worksurface Supports, Double-Sided FOR CENTER OF A RUN

DESCRIPTION

Worksurface supports for double-sided Extension Elements.

SPECIFICATION OPTIONS

**product #:** see charts below  
**finish:** see page 6

NOTES

- Not for use with Stand Alone Elements.
- Specify paint finish.
- Specify the correct size for unit.

ORDER EXAMPLE

**product #:** FVCLD-O  
**finish:** CW Cloud White

### OPEN CENTER LEG DOUBLE-SIDED 48"/60" DEEP UNIT

PART #	HEIGHT	WIDTH	DEPTH	WT. (LBS)	LIST
FVCLD-O	—	—	—	—	\$412

NOTES

- For double-sided 24" or 30" deep units.
- For use at the center of a run only.
- Leg style is open.

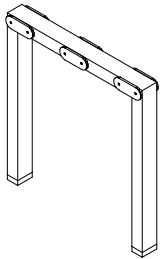

### ENCLOSED CENTER LEG DOUBLE-SIDED 48"/60" DEEP UNIT

PART #	HEIGHT	WIDTH	DEPTH	WT. (LBS)	LIST
FVCLD-C	—	—	—	—	\$701

NOTES

- For double-sided 24" or 30" deep units.
- For use at the center of a run only.
- Leg style is enclosed.

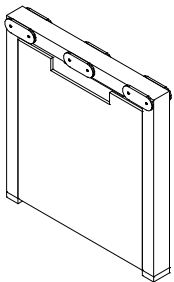

WORKSURFACE SUPPORTS



## Taper & Inset End of Run Support

DESCRIPTION

Taper and Inset Legs for use with the Verity system

SPECIFICATION OPTIONS

**product #:** see charts below  
**finish:** see page 8

NOTES

- Includes straight support bar
- For use at end of run

## Straight Support Bar

### TAPER LEG

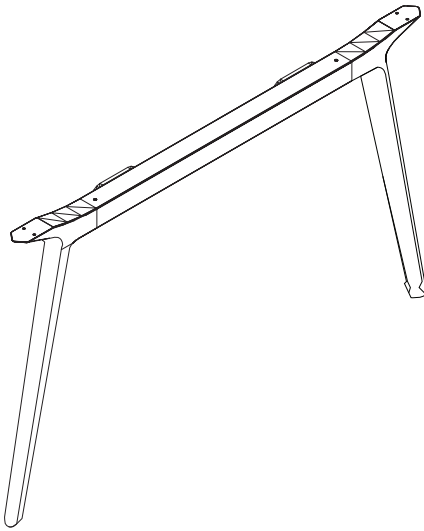

PART #	HEIGHT	DEPTH	LIST
FVSATPLD.48	27.5"	48"	\$987
FVSATPLD.60	27.5"	60"	\$1,003

NOTES

- Attaches to the underside of a worksurface
- Supports worksurface at the end of run
- Use with straight support beam

### INSET LEG

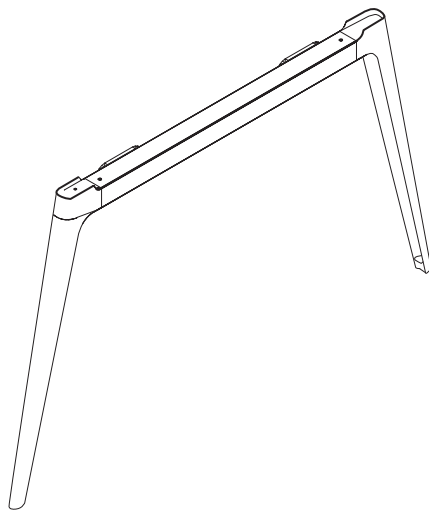

PART #	HEIGHT	DEPTH	LIST
FVSAINLD.48	27.5"	48"	\$1,122
FVSAINLD.60	27.5"	60"	\$1,137

NOTES

- Attaches to the underside of a worksurface
- Supports worksurface at the end of run
- Use with straight support beam

## Taper & Inset End of Run Support continued

DESCRIPTION

Taper and Inset Legs for use with the Verity system

SPECIFICATION OPTIONS

**product #:** see charts below  
**finish:** see page 8

NOTES

- Includes concave support bar
- For use at end of run

## Concave Support Bar

### TAPER LEGS

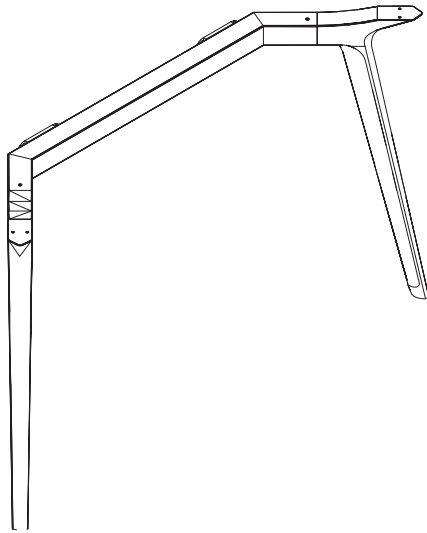

PART #	HEIGHT	DEPTH	LIST
FVCATPLD.48	27.5"	48"	\$998
FVCATPLD.60	27.5"	60"	\$1,024

NOTES

- Attaches to the underside of a worksurface at end of run
- Use with concave support beam
- Order start/end or stand alone element separately

### INSET LEGS

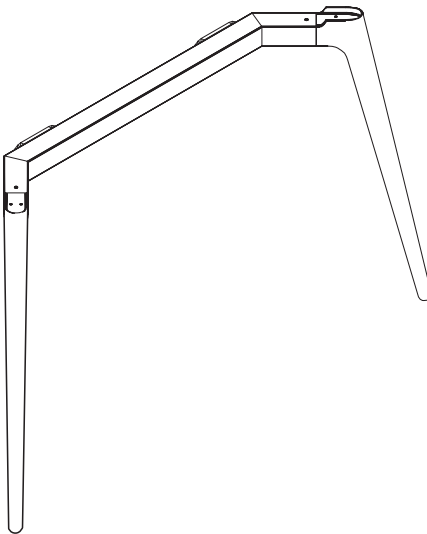

PART #	HEIGHT	DEPTH	LIST
FVCAINLD.48	27.5"	48"	\$1,133
FVCAINLD.60	27.5"	60"	\$1,161

NOTES

- Attaches to the underside of a worksurface at end of run
- Use with concave support beam
- Order start/end or stand alone element separately

WORKSURFACE SUPPORTS

**Worksurface Supports, Double-Sided** continued  
FOR CENTER OF A RUN

**CENTER TAPER LEG  
DOUBLE-SIDED  
48"/60" DEEP UNIT**

PART #	HEIGHT	WIDTH	DEPTH	WT. (LBS)	LIST
FVCLD-T	—	—	—	—	\$1,226

NOTES  
For double-sided 24" or 30" deep units.  
For use at the center of a run only

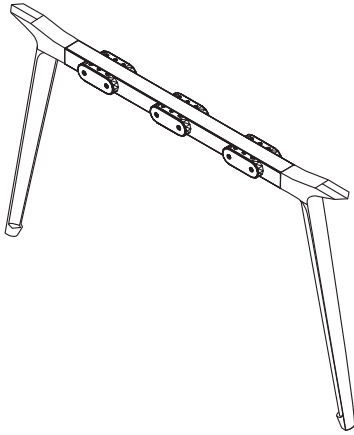

**CENTER INSET LEG  
DOUBLE-SIDED  
48"/60" DEEP UNIT**

PART #	HEIGHT	WIDTH	DEPTH	WT. (LBS)	LIST
FVCLD-I	—	—	—	—	\$1,090

NOTES  
For double-sided 24" or 30" deep units.  
For use at the center of a run only

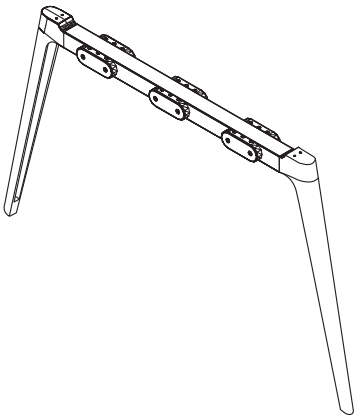

## Supporting Pedestals

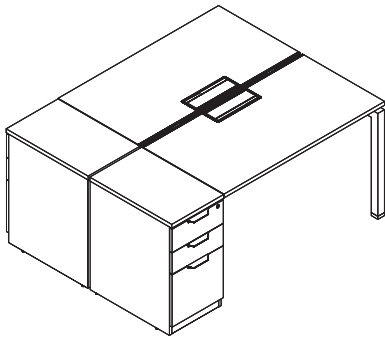

DESCRIPTION

Storage supports elements on one side.

SPECIFICATION OPTIONS

**product #:** see charts below  
**front, casing & worksurface finish (if applicable):** See worksurface laminates on page 8  
**pull:** See page 9

NOTES

- Order storage attachment bracket separately.
- Specify worksurface finish for pedestal top and front for drawers and for casing
- Specify pull when ordering
- Includes pencil tray in top drawer

ORDER EXAMPLE

**product #:** FVBBF.24-LAM  
**front finish:** M1 Light Maple  
**worksurface finish:** M1 Light Maple  
**casing finish:** M29 Raven

STORAGE PULL OPTIONS

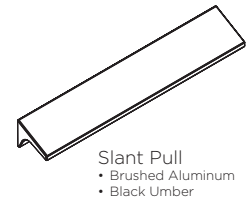
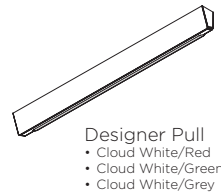
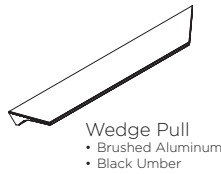

WORKSURFACE SUPPORTS

**SUPPORTING BOX/BOX/FILE PEDESTAL 24" DEPTH**

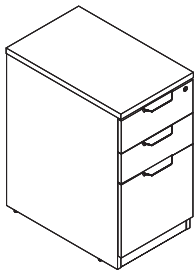

PART #	HEIGHT	WIDTH	DEPTH	WT. (LBS)	LIST	NOTES
FVBBF.24-LAM	29.5"	15.5"	24.75"	—	\$1,576	

- Supporting laminate pedestal storage with drawers and pulls.
- Worksurface height.
- Order storage attachment bracket (Part # FVSS.XX) separately on pg 58
- Can be freestanding.
- Specify worksurface finish for pedestal top, front finish for drawers and for casing.
- Specify pull when ordering
- Includes pencil tray in top drawer

## Supporting Storage, Pedestals...continued

### SUPPORTING BOX/BOX/FILE PEDESTAL 30" DEPTH

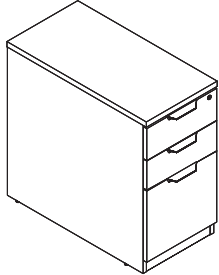

PART #	HEIGHT	WIDTH	DEPTH	WT. (LBS)	LIST	NOTES
FVBBF.30-LAM	29.5"	15.5"	30.75"	—	\$1,703	<ul style="list-style-type: none"> <li>Supporting laminate pedestal storage with drawers and pulls.</li> <li>Worksurface height.</li> <li>Order storage attachment bracket (Part # FVSS.XX) separately on pg 58</li> <li>Can be freestanding.</li> <li>Specify worksurface finish for pedestal top, front finish for drawers and for casing.</li> <li>Specify pull when ordering</li> <li>Includes pencil tray in top drawer</li> </ul>

### SUPPORTING FILE/FILE PEDESTAL 24" DEPTH

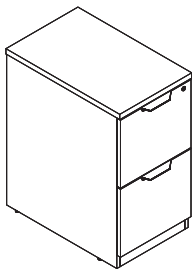

PART #	HEIGHT	WIDTH	DEPTH	WT. (LBS)	LIST	NOTES
FVFF.24-LAM	29.5"	15.5"	24.75"	—	\$1,576	<ul style="list-style-type: none"> <li>Supporting laminate pedestal storage with drawers and pulls.</li> <li>Worksurface height.</li> <li>Order storage attachment bracket (Part # FVSS.XX) separately on pg 58</li> <li>Can be freestanding.</li> <li>Specify worksurface finish for pedestal top, front finish for drawers and for casing.</li> <li>Specify pull when ordering</li> <li>Includes pencil tray in top drawer</li> </ul>

### SUPPORTING FILE/FILE PEDESTAL 30" DEPTH

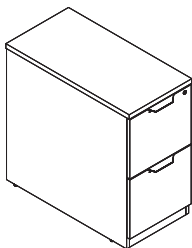

PART #	HEIGHT	WIDTH	DEPTH	WT. (LBS)	LIST	NOTES
FVFF.30-LAM	29.5"	15.5"	30.75"	—	\$1,703	<ul style="list-style-type: none"> <li>Supporting laminate pedestal storage with drawers and pulls.</li> <li>Worksurface height.</li> <li>Order storage attachment bracket (Part # FVSS.XX) separately on pg 58</li> <li>Can be freestanding.</li> <li>Specify worksurface finish for pedestal top, front finish for drawers and for casing.</li> <li>Specify pull when ordering</li> <li>Includes pencil tray in top drawer</li> </ul>

## Supporting Credenzas

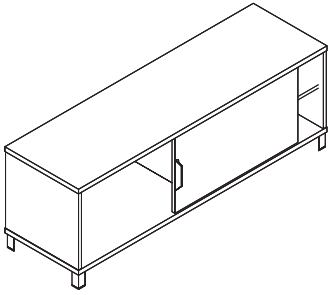

### DESCRIPTION

Laminate storage credenzas with open shelves and sliding doors with pull.

### NOTES

- Specify: Top, Front, Case, Pull & Foot.
- Pulls have color options: specify color when ordering. (See page 9)
- Specify L for left or R for right indicating door pull location.

### SPECIFICATION OPTIONS

**product #:** see charts below  
**front finish:** see page 8  
**top finish:** see page 8  
**casing finish:** see page 8  
**left or right:** L for Left, R for Right  
**pull:** See page 9  
**foot finish:** BU, CW, SV

### ORDER EXAMPLE

**product #:** FVBSC.1860  
**front finish:** M1 Light Maple  
**top finish:** M1 Light Maple  
**casing finish:** M29 Raven  
**left or right:** L for Left  
**pull:** Wedge, brushed aluminum  
**foot finish:** CW

## CREDENZA

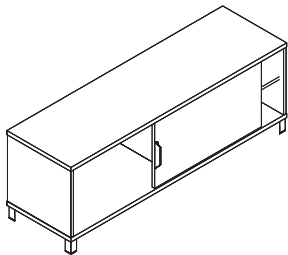

PART #	HEIGHT	WIDTH	DEPTH	WT. (LBS)	LIST	NOTES
FVBSC.1848 L/R	21.25"	48"	17.75"	—	\$1,473	Specify L for left or R for right indicating door pull location
FVBSC.1860 L/R	21.25"	60"	17.75"	—	\$1,667	
FVBSC.1872 L/R	21.25"	72"	17.75"	—	\$1,923	Specify: Top, Front, Case, Pull & Foot finish

## Supporting Cabinets

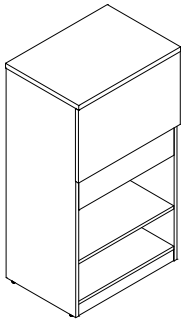

### DESCRIPTION

Storage support elements on one side.

### SPECIFICATION OPTIONS

**product #:** see charts below  
**front, casing & worksurface finish (if applicable):** See worksurface laminates on page 8  
**fabric:** See page 6

### NOTES

- Order storage attachment bracket separately (pg 58).
- Specify worksurface finish for top and for casing
- Specify fabric on page 6

### ORDER EXAMPLE

**product #:** FVWSTT.1824  
**front finish:** M1 Light Maple  
**worksurface finish:** M1 Light Maple  
**casing finish:** M29 Raven  
**fabric:** PF401-Silky-Natural

### SUPPORTING CABINET: TACKBOARD & BOOKCASE

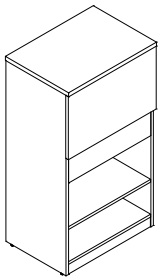

front shown

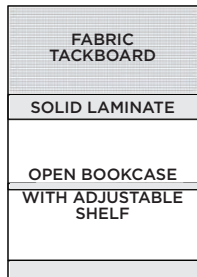

FRONT

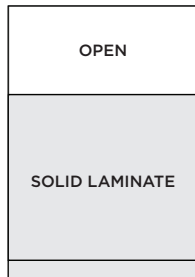

BACK

PART #	HEIGHT	WIDTH	DEPTH	WT. (LBS)	LIST
FVWSTT.1824	45"	24.75"	18"	—	\$1,471
FVWSTT.1830	45"	30.75"	18"	—	\$1,691

### NOTES

Supporting laminate cabinets with tackboard top and open bookcase bottom on one side, with open top and solid surface on the opposite side. Specify fabric for tackboard.

### SUPPORTING CABINET: OPEN & BOOKCASE

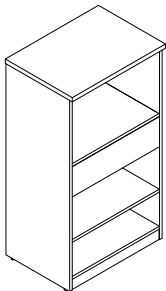

front shown

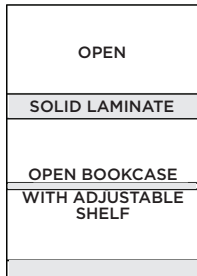

FRONT



BACK

PART #	HEIGHT	WIDTH	DEPTH	WT. (LBS)	LIST
FVWSTO.1824	45"	24.75"	18"	—	\$1,230
FVWSTO.1830	45"	30.75"	18"	—	\$1,364

### NOTES

Supporting laminate cabinets with open top and open bookcase bottom on one side, with solid surface on the opposite side.

### SUPPORTING CABINET: TACKBOARD & SHARED BOOKCASE

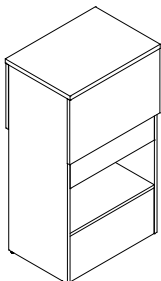

front shown

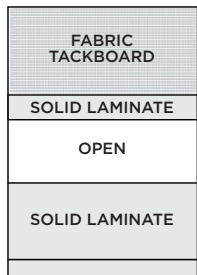

FRONT

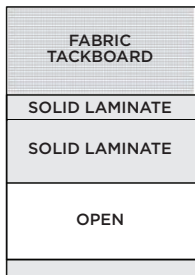

BACK

PART #	HEIGHT	WIDTH	DEPTH	WT. (LBS)	LIST
FVWSTS.1824	45"	24.75"	18"	—	\$1,579
FVWSTS.1830	45"	30.75"	18"	—	\$1,858

### NOTES

Supporting laminate cabinets with tackboard top and shared bookcase bottom on both sides. Shared bookcase has one open shelf and one solid surface on each side. Specify fabric for tackboard.

## Supporting Storage Attachment Brackets

<p><b>DESCRIPTION</b></p> <p>Worksurface attachment brackets for use with supporting storage.</p>	<p><b>SPECIFICATION OPTIONS</b></p> <p><b>product #:</b> see charts below <b>finish:</b> see page 8</p>
<p><b>NOTES</b></p> <ul style="list-style-type: none"> <li>Specify paint finish.</li> <li>Specify the correct size for unit.</li> </ul>	<p><b>ORDER EXAMPLE</b></p> <p><b>product #:</b> FVCLD <b>finish:</b> CW Cloud White</p>

WORKSURFACE SUPPORTS

### STORAGE ATTACHMENT BRACKET, 48" DEEP

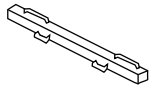

PART #	HEIGHT	WIDTH	DEPTH	WT. (LBS)	LIST
FVSS.24	—	—	48"	—	\$227

**NOTES**

**For use at the start or end of a run only.**

Supports two 24" deep tops. Worksurface supporting bracket for attaching pedestal or cabinet. Order one attachment bracket per attachment location.

### STORAGE ATTACHMENT BRACKET, 60" DEEP

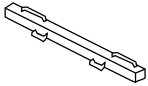

PART #	HEIGHT	WIDTH	DEPTH	WT. (LBS)	LIST
FVSS.30	—	—	60"	—	\$251

**NOTES**

**For use at the start or end of a run only.**

Supports two 30" deep tops. Worksurface supporting bracket for attaching pedestal or cabinet. Order one attachment bracket per attachment location.

### CREDENZA ATTACHMENT BRACKET DOUBLE-SIDED 24"/30" DEEP UNIT

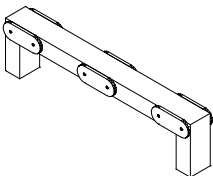

PART #	HEIGHT	WIDTH	DEPTH	WT. (LBS)	LIST
FVCCLD	—	—	—	—	\$321

**NOTES**

**For use at the center of a run only.**

For double-sided 24" or 30" deep units. Used with two supporting credenzas to support the worksurface.



## Gallery Panels, Double Sided, End of Run

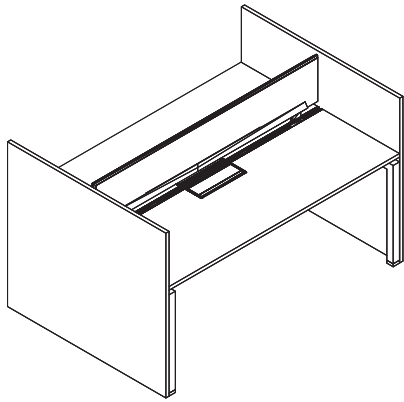

### DESCRIPTION

Laminate gallery panels connect to the end of a Verity run

### NOTES

- Used at the end of a Verity run
- Attachment hardware is included.
- Gallery panels provide modesty, not structural support. Legs are still required

### SPECIFICATION OPTIONS

**product #:** see charts below  
**surface finish:** See page 8  
**finish:** see page 8

### ORDER EXAMPLE

**product #:** FVGPEORD.2948  
**surface finish:** M10 Espresso  
**finish:** CW

### 29" HIGH

PART #	HEIGHT	WIDTH	DEPTH	PRICE
FVGPEORD.2948	29"	50.5"	1"	\$684
FVGPEORD.2960	29"	62.5"	1"	\$761

### 44" HIGH

PART #	HEIGHT	WIDTH	DEPTH	PRICE
FVGPEORD.4448	44"	50.5"	1"	\$859
FVGPEORD.4460	44"	62.5"	1"	\$973

## Gallery Panels, Single Sided, End of Run

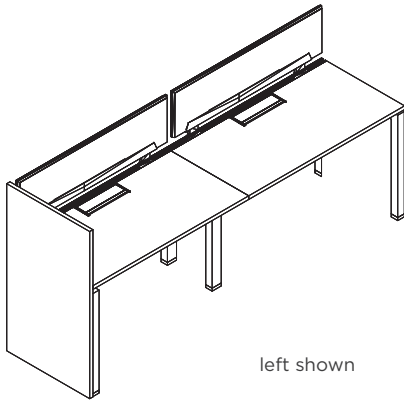

left shown

### DESCRIPTION

Laminate gallery panels connect to the end of a Verity run

### NOTES

- Used at the end of a Verity run
- Attachment hardware is included.
- Gallery panels provide modesty, not structural support. Legs are still required

### SPECIFICATION OPTIONS

**product #:** see charts below  
**surface finish:** See page 8  
**finish:** see page 8

### ORDER EXAMPLE

**product #:** FVGPEORS.2930L  
**surface finish:** M10 Espresso  
**finish:** CW

### 29" HIGH

PART #	HEIGHT	WIDTH	DEPTH	PRICE
FVGPEORS.2924L	29"	24.5"	1"	\$529
FVGPEORS.2924R	29"	24.5"	1"	\$529
FVGPEORS.2930L	29"	30.5"	1"	\$567
FVGPEORS.2930R	29"	30.5"	1"	\$567

### 44" HIGH

PART #	HEIGHT	WIDTH	DEPTH	PRICE
FVGPEORS.4424L	44"	24.5"	1"	\$633
FVGPEORS.4424R	44"	24.5"	1"	\$633
FVGPEORS.4430L	44"	30.5"	1"	\$690
FVGPEORS.4430R	44"	30.5"	1"	\$690

# Electrical Distribution

DESCRIPTION	SPECIFICATION OPTIONS
Electrical distribution components.	<b>product #:</b> see charts below
NOTES	ORDER EXAMPLE
	<b>product #:</b> FVBPI.4CIR

## 4-CIRCUIT POWER INFEED



PART #	HEIGHT	WIDTH	DEPTH	WT. (LBS)	LIST	NOTES
FVBPI.4CIR	—	6'	—	—	\$452	Hardwire power infeed for use with 4-circuit power distribution.  MUST BE HARDWIRED BY AN ELECTRICIAN.

## POWER POLE

PART #	HEIGHT	WIDTH	DEPTH	WT. (LBS)	LIST	NOTES
FVPP-S	—	—	—	—	\$992	Connects a ceiling electrical supply to the trough of a powered element. Distributes up to four 20-amp circuits.  Includes a rigid conduit and conduit connector, factory installed power harness, 12' pole.  <ul style="list-style-type: none"> <li>Attaches to Single side unit order FVPP-S.</li> <li>Double sided order FVPP-D. Available in CW only.</li> </ul> MUST BE HARDWIRED BY AN ELECTRICIAN.
FVPP-D	—	—	—	—	\$992	

## RECEPTACLE 4-CIRCUITS

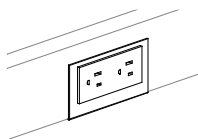

PART #	DESCRIPTION	LIST	NOTES
FVRECP.I	circuit A	\$37	Provides access to I, II, III, IIII circuit.
FVRECP.II	circuit B	\$37	
FVRECP.III	circuit C	\$37	Provides dedicated circuit with "IIII" receptacle.  Receptacle -CONT are permanently marked CONTROLLED on the face of the receptacle and must be connected to a timer or motion sensor at the infeed location by a licensed electrician in order to comply with California T24
FVRECP.IIIII	circuit D (dedicated)	\$37	
FVRECP.II-CONT	circuit B	\$37	
FVRECP.III-CONT	circuit C	\$37	

## WIRE MANAGER

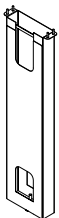

PART #	HEIGHT	WIDTH	DEPTH	WT. (LBS)	LIST	NOTES
FVWM	28"	—	—	—	\$168	A housing that conceals power & other wires from the floor to the trough.  Wire manager is 6.5" wide x 2" deep  CW, BU, or SV finish.

**Electrical Distribution** continued

**DATA PORT PLATE**

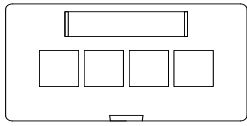

PART #	HEIGHT	WIDTH	DEPTH	WT. (LBS)	LIST
FVDPP	2.125	3.625	0.25	0.10	\$61

**NOTES**

---

For use with non-powered structures only.

Includes four port locations and comes with one blank insert.

Data port plates are included with powered Elements.

Available in BU, CW, SV

**DOUBLE SIDED CONNECTING TROUGH**

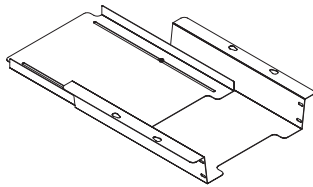

PART #	HEIGHT	WIDTH	DEPTH	WT. (LBS)	LIST
FV-DCT	—	—	—	—	\$201

**NOTES**

---

Included in the elements and sold here separately for special situations.

**SINGLE SIDED CONNECTING TROUGH**

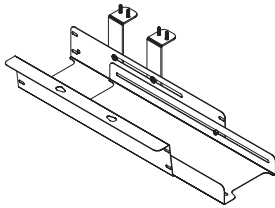

PART #	HEIGHT	WIDTH	DEPTH	WT. (LBS)	LIST
FV-SCT	—	—	—	—	\$130

**NOTES**

---

Included in the elements and sold here separately for special situations.

**DOUBLE SIDED TROUGH, POWERED**

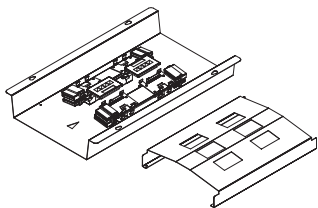

PART #	HEIGHT	WIDTH	DEPTH	WT. (LBS)	LIST
FV-DT-E4	—	—	—	—	\$497

**NOTES**

---

Included in the elements and sold here separately for special situations.

Order Duplexes/infeed jumpers separate

**SINGLE SIDED TROUGH, POWERED**

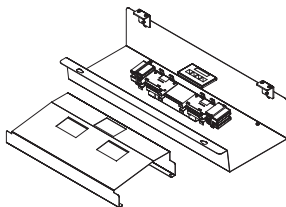

PART #	HEIGHT	WIDTH	DEPTH	WT. (LBS)	LIST
FV-ST-E4	—	—	—	—	\$254

**NOTES**

---

Included in the elements and sold here separately for special situations.

Order Duplexes/infeed jumpers separate

ELECTRICAL DISTRIBUTION

## Electrical Distribution continued

### 4-CIRCUIT POWER JUMPER



PART #	HEIGHT	WIDTH	DEPTH	WT. (LBS)	LIST	NOTES
FVJUMP.48	—	40"	—	—	\$355	Connects power from one Element to another.
FVJUMP.54	—	46"	—	—	\$385	
FVJUMP.60	—	52"	—	—	\$427	For a 96"W element, order one additional for middle 48" power jumper, FVJUMP.48.
FVJUMP.66	—	58"	—	—	\$465	
FVJUMP.72	—	64"	—	—	\$499	When connecting two elements of equal width, order Power Jumper to match width of elements.
FVJUMP.78	—	70"	—	—	\$538	
FVJUMP.84	—	76"	—	—	\$580	

When connecting two elements of different width, reference chart below for applicale Jumper size.

### Power Jumper Sizing Chart

	48	54	60	66	72	78	84
48	FVJUMP.48	FVJUMP.54	FVJUMP.54	FVJUMP.60	FVJUMP.60	FVJUMP.66	FVJUMP.66
54	FVJUMP.54	FVJUMP.54	FVJUMP.60	FVJUMP.60	FVJUMP.66	FVJUMP.66	FVJUMP.72
60	FVJUMP.54	FVJUMP.60	FVJUMP.60	FVJUMP.66	FVJUMP.66	FVJUMP.72	FVJUMP.72
66	FVJUMP.60	FVJUMP.60	FVJUMP.66	FVJUMP.66	FVJUMP.72	FVJUMP.72	FVJUMP.78
72	FVJUMP.60	FVJUMP.66	FVJUMP.66	FVJUMP.72	FVJUMP.72	FVJUMP.78	FVJUMP.78
78	FVJUMP.66	FVJUMP.66	FVJUMP.72	FVJUMP.72	FVJUMP.78	FVJUMP.78	FVJUMP.84
84	FVJUMP.66	FVJUMP.72	FVJUMP.72	FVJUMP.78	FVJUMP.78	FVJUMP.84	FVJUMP.84

#### Example Jumper Calculation

Calculate the jumper needed between element A and element B.

Step 1 - Take the width of the first element and find that number in the left column.

A is 54" and 54 is the second row down in the table.

Step 2 - Take the width of the second element and find that number across the top.

B is 78" and 78 is sixth column to the right.

Step 3 - Where the row and column intersect that is the required jumper needed.

54 and 78 intersects at FVJUMP.66.

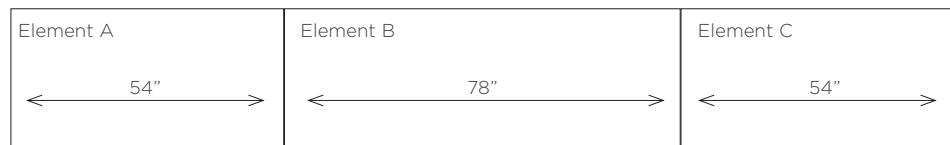

Jumper  
FVJUMP.66

Jumper  
FVJUMP.66

**Electrical Distribution** continued

**CHICAGO POWER BOX  
SINGLE-SIDED**

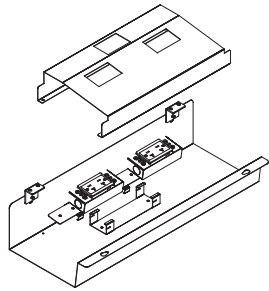

PART #	HEIGHT	WIDTH	DEPTH	WT. (LBS)	LIST
FVCPB.S					\$114

- NOTES
- Chicago Power Boxes house electrical components provided by others
  - For use with non-powered Verity elements
  - Can accommodate 2 duplexes (provided by others)

**CHICAGO POWER BOX  
DOUBLE-SIDED**

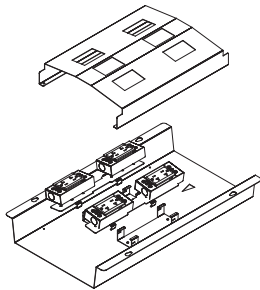

PART #	HEIGHT	WIDTH	DEPTH	WT. (LBS)	LIST
FVCPB.D					\$150

- NOTES
- Chicago Power Boxes house electrical components provided by others
  - For use with non-powered Verity elements
  - Can accommodate 4 duplexes (provided by others)

ELECTRICAL DISTRIBUTION

## Power Grommet Worksurface Mounted

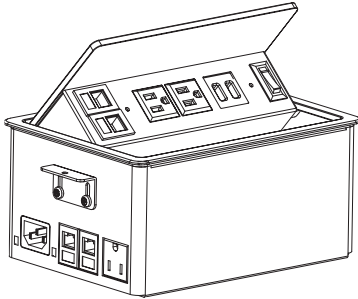

DESCRIPTION

Worksurface mounted power/data grommet

SPECIFICATION OPTIONS

**product #:** see charts below  
**finish:** BA Brushed Aluminum, BC Brushed Charcoal or CW Cloud White (contact Customer Success for lead time)

NOTES

- Power grommets for use with ancillary tops only, Verity Elements include built-in power access.
- Includes 10' coiled power cord to connect to power source, or daisy chain to next power grommet

ORDER EXAMPLE

**product #:** FPWR.0608  
**finish:** BA Brushed Aluminum

### POWER GROMMET, 5x8

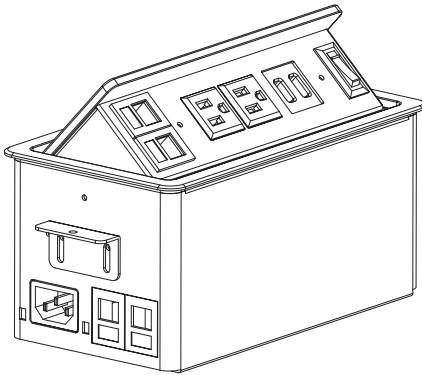

PART #	HEIGHT	WIDTH	DEPTH	PRICE	NOTES
FPWR.0508		8"	5"	\$695	<ul style="list-style-type: none"> <li>• Worksurface mounted power/data grommet, 5x8</li> <li>• Includes 10' coiled power cord to connect to power source</li> <li>• Distributes up to 10 amps</li> <li>• <b>Above Worksurface:</b></li> <li>• (2) CAT6 data ports (out), (2) power outlets, (2) USB ports</li> <li>• <b>Below Worksurface:</b> (2) CAT6 data ports (in), (1) power outlet, Daisy Chain ports (in/out)</li> </ul>

### POWER GROMMET, 6x8

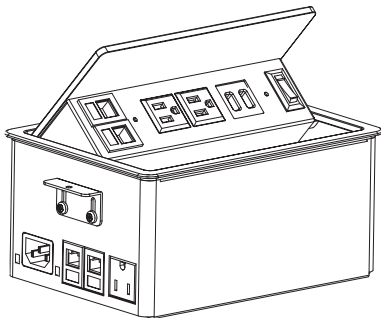

PART #	HEIGHT	WIDTH	DEPTH	PRICE	NOTES
FPWR.0608		8"	6"	\$695	<ul style="list-style-type: none"> <li>• Worksurface mounted power/data grommet, 6x8</li> <li>• Includes 10' coiled power cord to connect to power source</li> <li>• Distributes up to 10 amps</li> <li>• <b>Above Worksurface:</b></li> <li>• (2) CAT6 data ports (out), (2) power outlets, (2) USB ports</li> <li>• <b>Below Worksurface:</b> (2) CAT6 data ports (in), (2) power outlets, Daisy Chain ports (in/out)</li> </ul>

## Rectangular Worksurfaces For Use w/ MY-HITE Base

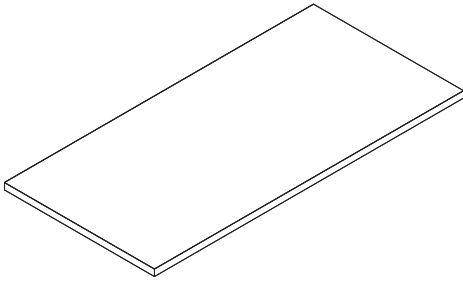

DESCRIPTION

Worksurface top only, for use with height adjustable base within workstation application

NOTES

- Add circular grommet (add \$75 list) Specify GL, GC, GR
- Order base separately from MY-HITE pricebook

Note: Top size reduced 1" in depth and 2" in width to fit within system workstation and prevent pinch points. See system pricebook for details. We do not recommend using full size worktop in paneled workstation applications.

SPECIFICATION OPTIONS

**product #:** see charts below  
**top, edge finish:** worksurface finish:  
 see page 8

ORDER EXAMPLE

**product #:** FVRSW.2370  
**edge finish:** DT Dark Tone, E12  
**worksurface finish:** Light Maple, M1  
**grommet:** GC (Rear Center)

**RECTANGULAR WORKSURFACE**

PART #	DEPTH	WIDTH	PRICE	NOTES
FVRWS.2340	23"	40"	\$380	Sizes are actual for example FVRSW.2358 is 23" x 58"
FVRWS.2346	23"	46"	\$392	
FVRWS.2352	23"	52"	\$463	
FVRWS.2358	23"	58"	\$474	
FVRWS.2364	23"	64"	\$545	
FVRWS.2370	23"	70"	\$561	
FVRWS.2376	23"	76"	\$684	
FVRWS.2382	23"	82"	\$691	
FVRWS.2940	29"	40"	\$449	
FVRWS.2946	29"	46"	\$463	
FVRWS.2952	29"	52"	\$547	
FVRWS.2958	29"	58"	\$561	
FVRWS.2964	29"	64"	\$650	
FVRWS.2970	29"	70"	\$664	
FVRWS.2976	29"	76"	\$818	
FVRWS.2982	29"	82"	\$824	
FVRWS.3540	35"	40"	\$473	
FVRWS.3546	35"	46"	\$480	
FVRWS.3552	35"	52"	\$843	
FVRWS.3558	35"	58"	\$852	
FVRWS.3564	35"	64"	\$862	
FVRWS.3570	35"	70"	\$871	
FVRWS.3576	35"	76"	\$879	
FVRWS.3582	35"	82"	\$1,005	

WORKSURFACE (MY-HITE)



## Rectangular Extension Worksurfaces For Use w/ MY-HITE Base

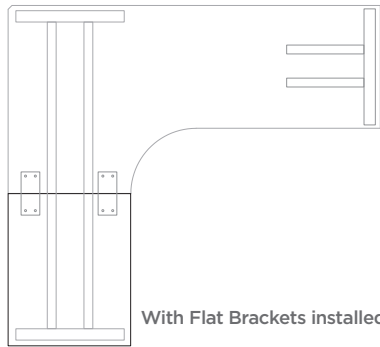

### DESCRIPTION

Laminate worksurface, for use with extended curved corner worksurfaces, not for use alone.

### NOTES

- For use in combination with Extended Corner Worksurfaces and Corner My-Hite Bases only
- Not for use alone, nor with straight bases
- Maximum width combined: 72x96" or 84x84"

### SPECIFICATION OPTIONS

**product #:** See charts below  
**worksurface finish:** See page 8

### ORDER EXAMPLE

**product #:** FVRWS.2324  
**worksurface:** Light Maple, M1

## RECTANGULAR WORKSURFACE

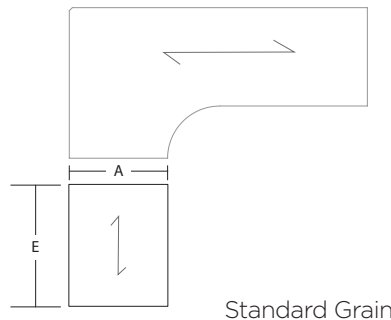

PART #	DEPTH "A"	WIDTH "E"	LIST
FVRWS.2324	23"	24"	\$299
FVRWS.2330	23"	30"	\$342
FVRWS.2336	23"	36"	\$353
FVRWS.2924	29"	24"	\$396
FVRWS.2930	29"	30"	\$451
FVRWS.2936	29"	36"	\$464

### NOTES

- Standard default grain direction is left to right (See left)

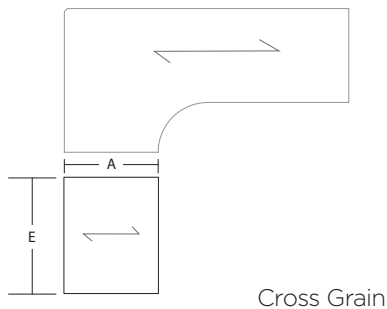

PART #	DEPTH "A"	WIDTH "E"	LIST
FVRWS.2324-CG	23"	24"	\$357
FVRWS.2330-CG	23"	30"	\$409
FVRWS.2336-CG	23"	36"	\$423
FVRWS.2924-CG	29"	24"	\$475
FVRWS.2930-CG	29"	30"	\$542
FVRWS.2936-CG	29"	36"	\$557

### NOTES

- Cross grain direction is front to back (See left)

## FLAT BRACKET

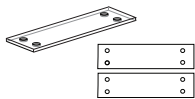

PART #	WIDTH	DEPTH	PRICE
FVFB.08	8"	2"	\$38

### NOTES

- Used to unite two worksurfaces supported by one base
- Black finish
- Sold in pairs

## ANTI-SAG BARS



PART #	WIDTH	LIST
FWASB.42	42"	\$120
FWASB.54	54"	\$153
FWASB.66	66"	\$185

### NOTES

- Anti-Sag bar, 42" wide with (8) screws. For use with 48 & 54" worktops
- Anti-Sag bar, 54" wide with (10) screws. For use with 60 & 66" worktops
- Anti-Sag bar, 66" wide with (12) screws. For use with 72 & 78" worktops

## Wedge Worksurface For Use w/ MY-HITE Bases

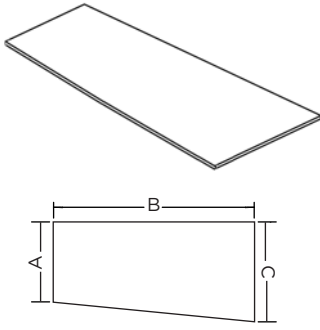

### DESCRIPTION

Worksurface top only, for use with height adjustable base within workstation application

### NOTES

- Add grommet (add \$75 list)  
Specify GL, GC, GR
- Order base separately from MY-HITE pricebook

Note: Top size reduced 1" in depth and 2" in width to fit within system workstation and prevent pinch points. We do not recommend using full size worktop in paneled workstation applications.

### SPECIFICATION OPTIONS

**product #:** see charts below  
**top, edge finish:** worksurface finish:  
see page 8

### ORDER EXAMPLE

**product #:** FVWDWS.234029  
**edge finish:** DT Dark Tone, E12  
**worksurface finish:** Espresso, M10  
**grommet:** GC (Rear Center)

### 23"D LEFT 29"D RIGHT

PART #	A	B	C	D	PRICE
FVWDWS.234029	23"	40"	29"	—	\$444
FVWDWS.234629	23"	46"	29"	—	\$452
FVWDWS.235229	23"	52"	29"	—	\$514
FVWDWS.235829	23"	58"	29"	—	\$550
FVWDWS.236429	23"	64"	29"	—	\$614
FVWDWS.237029	23"	70"	29"	—	\$628
FVWDWS.237629	23"	76"	29"	—	\$729

### 29"D LEFT 23"D RIGHT

PART #	A	B	C	D	PRICE
FVWDWS.294023	29"	40"	23"	—	\$444
FVWDWS.294623	29"	46"	23"	—	\$452
FVWDWS.295223	29"	52"	23"	—	\$514
FVWDWS.295823	29"	58"	23"	—	\$550
FVWDWS.296423	29"	64"	23"	—	\$614
FVWDWS.297023	29"	70"	23"	—	\$628
FVWDWS.297623	29"	76"	23"	—	\$729

WORKSURFACE (MY-HITE)

## D-Shaped Worksurface For Use w/ MY-HITE Bases

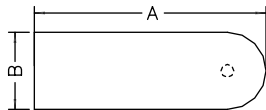
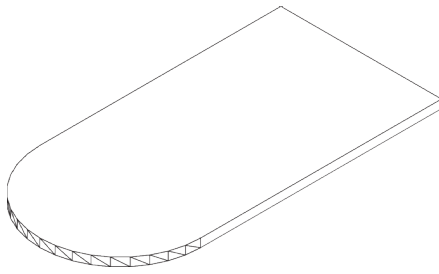

### DESCRIPTION

Worksurface top only, for use with height adjustable base within workstation application

### NOTES

- Add grommet (add \$75 list)  
Specify GL, GC, GR
- Order base separately from MY-HITE pricebook

Note: Top size reduced 1" in depth and 2" in width to fit within system workstation and prevent pinch points. We do not recommend using full size worktop in paneled workstation applications.

### SPECIFICATION OPTIONS

**product #:** see charts below  
**top, edge finish:** worksurface finish:  
see page 8

### ORDER EXAMPLE

**product #:** FVEDSP.2346  
**edge finish:** DT Dark Tone, E12  
**worksurface finish:** Espresso, M10  
**grommet:** GC (Rear Center)

### D-SHAPED

PART #	A	B	C	D	PRICE
FVEDSP.2346	46"	23"	—	—	\$572
FVEDSP.2358	58"	23"	—	—	\$638
FVEDSP.2946	46"	29"	—	—	\$628
FVEDSP.2958	58"	29"	—	—	\$697
FVEDSP.2970	70"	29"	—	—	\$760
FVEDSP.3570	70"	35"	—	—	\$839

## 120° Corner / 90° Ends Worksurface For Use w/ MY-HITE Bases

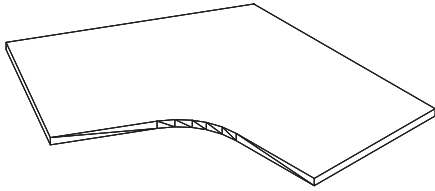

DESCRIPTION

Worksurface top only, for use with height adjustable base within workstation application

NOTES

- Add grommet (add \$75 list)  
Specify 120GL, 120GC, 120GR
- Order base separately from MY-HITE pricebook

Note: Top size reduced 1" in depth and 2" in width to fit within system workstation and prevent pinch points. We do not recommend using full size worktop in paneled workstation applications.

SPECIFICATION OPTIONS

**product #:** see charts below  
**top, edge finish:** worksurface finish:  
see page 8

ORDER EXAMPLE

**product #:** FV120-90WS.2334  
**edge finish:** DT Dark Tone, E12  
**worksurface finish:** Espresso, M10  
**grommet:** 120GC (Rear Center)

### 120° CORNER 90° ENDS

PART #	A	B	C	D	PRICE
FV120-90WS.2334	23"	34"	—	—	\$820
FV120-90WS.2340	23"	40"	—	—	\$1,010
FV120-90WS.2346	23"	46"	—	—	\$1,259

## 120° Corner / 120° Ends Worksurface For Use w/ MY-HITE Bases

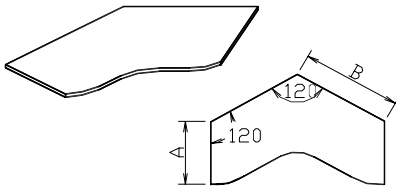

DESCRIPTION

Worksurface top only, for use with height adjustable base within workstation application

NOTES

- Add grommet (add \$75 list)  
Specify 120GL, 120GC, 120GR
- Order base separately from MY-HITE pricebook

Note: Top size reduced 1" in depth and 2" in width to fit within system workstation and prevent pinch points. We do not recommend using full size worktop in paneled workstation applications.

SPECIFICATION OPTIONS

**product #:** see charts below  
**top, edge finish:** worksurface finish:  
see page 8

ORDER EXAMPLE

**product #:** FV120-120WS.2334  
**edge finish:** DT Dark Tone, E12  
**worksurface finish:** Espresso, M10  
**grommet:** 120GC (Rear Center)

### 120° CORNER 120° ENDS

PART #	A	B	C	D	PRICE
FV120-120WS.2334	23"	34"	—	—	\$820
FV120-120WS.2340	23"	40"	—	—	\$1,010
FV120-120WS.2346	23"	46"	—	—	\$1,259

## Corner Worksurfaces For Use w/ MY-HITE Base

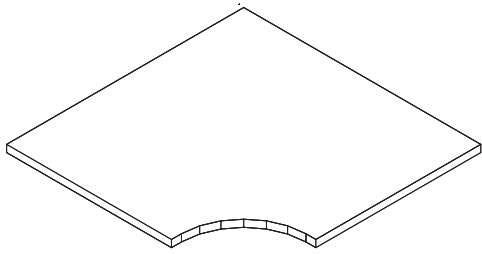

DESCRIPTION

Corner worksurface top only, for use with height adjustable base within workstation application.

NOTES

- Add circular grommet (add \$75 list)
- Specify GL or GR
- Order base separately from MY-HITE pricebook

Note: Top size reduced 1" in depth and 2" in width to fit within system workstation and prevent pinch points. See system pricebook for details. We do not recommend using full size worktop in paneled workstation applications.

SPECIFICATION OPTIONS

**product #:** see charts below  
**top, edge finish:** worksurface finish:  
 see page 8

ORDER EXAMPLE

**product #:** FVCWT.2340  
**edge finish:** DT Dark Tone, E12  
**worksurface finish:** Light Maple, M1  
**grommet:** GL

**CORNER WORKSURFACE**

PART #	DEPTH	WIDTH	PRICE
FVCWT.2340	23"	40"	\$626
FVCWT.2346	23"	46"	\$662
			\$681
FVCWT.2940	29"	40"	\$715
FVCWT.2946	29"	46"	\$638

NOTES

Sizes are actual for example  
 FVCWT.2940 is 29" x 40"

## 90° Extended Curved Corner Worksurface For Use w/ MY-HITE Bases

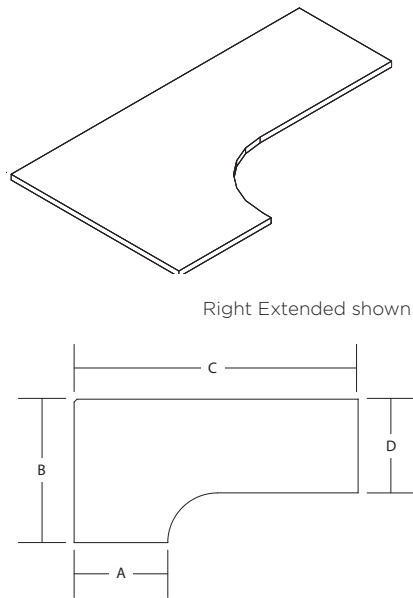

**DESCRIPTION**

Laminate worksurface with 3mm PVC edge

**NOTES**

- Worksurface top only, for use with height adjustable base within workstation application
- See My-Hite pricebook for use inside a freestanding application
- Add circular grommet (add \$75 list) Specify grommet placement GL, GC, GR
- Top size reduced 1" in depth and 2" in width to fit within system workstation and prevent pinch points.
- We do not recommend using full size worktop in paneled workstation applications

**SPECIFICATION OPTIONS**

**product #:** see charts below  
**top, edge, worksurface finish:** see page 8  
**left or right extended:** L for Left, R for Right

**ORDER EXAMPLE**

**product #:** FVECCWS.23345823L  
**top, edge finish:** E10 Espresso  
**worksurface finish:** M11 Light Walnut

WORKSURFACE (MY-HITE)

**23" D CONNECTING SIDE  
 23" D EXTENSION  
 34" D**

PART #	A	B	C	D	PRICE
FVECCWS.23345823L	23"	34"	58"	23"	\$718
FVECCWS.23345823R	23"	34"	58"	23"	\$718
FVECCWS.23346423L	23"	34"	64"	23"	\$800
FVECCWS.23346423R	23"	34"	64"	23"	\$800
FVECCWS.23347023L	23"	34"	70"	23"	\$813
FVECCWS.23347023R	23"	34"	70"	23"	\$813
FVECCWS.23347623L	23"	34"	76"	23"	\$974
FVECCWS.23347623R	23"	34"	76"	23"	\$974
FVECCWS.23348223L	23"	34"	82"	23"	\$1,081
FVECCWS.23348223R	23"	34"	82"	23"	\$1,081

**29" D CONNECTING SIDE  
 29" D EXTENSION  
 34" D**

PART #	A	B	C	D	PRICE
FVECCWS.29345829L	29"	34"	58"	29"	\$786
FVECCWS.29345829R	29"	34"	58"	29"	\$786
FVECCWS.29346429L	29"	34"	64"	29"	\$868
FVECCWS.29346429R	29"	34"	64"	29"	\$868
FVECCWS.29347029L	29"	34"	70"	29"	\$879
FVECCWS.29347029R	29"	34"	70"	29"	\$879
FVECCWS.29347629L	29"	34"	76"	29"	\$1,042
FVECCWS.29347629R	29"	34"	76"	29"	\$1,042
FVECCWS.29348229L	29"	34"	82"	29"	\$1,145
FVECCWS.29348229R	29"	34"	82"	29"	\$1,145

**23" D CONNECTING SIDE  
23" D EXTENSION  
40" D**

PART #	A	B	C	D	PRICE
FVECCWS.23405823L	23"	40"	58"	23"	\$865
FVECCWS.23405823R	23"	40"	58"	23"	\$865
FVECCWS.23406423L	23"	40"	64"	23"	\$972
FVECCWS.23406423R	23"	40"	64"	23"	\$972
FVECCWS.23407023L	23"	40"	70"	23"	\$987
FVECCWS.23407023R	23"	40"	70"	23"	\$987
FVECCWS.23407623L	23"	40"	76"	23"	\$1,196
FVECCWS.23407623R	23"	40"	76"	23"	\$1,196
FVECCWS.23408223L	23"	40"	82"	23"	\$1,335
FVECCWS.23408223R	23"	40"	82"	23"	\$1,335

**29" D CONNECTING SIDE  
29" D EXTENSION  
40" D**

PART #	A	B	C	D	PRICE
FVECCWS.29405829L	29"	40"	58"	29"	\$931
FVECCWS.29405829R	29"	40"	58"	29"	\$931
FVECCWS.29406429L	29"	40"	64"	29"	\$1,038
FVECCWS.29406429R	29"	40"	64"	29"	\$1,038
FVECCWS.29407029L	29"	40"	70"	29"	\$1,054
FVECCWS.29407029R	29"	40"	70"	29"	\$1,054
FVECCWS.29407629L	29"	40"	76"	29"	\$1,264
FVECCWS.29407629R	29"	40"	76"	29"	\$1,264
FVECCWS.29408229L	29"	40"	82"	29"	\$1,401
FVECCWS.29408229R	29"	40"	82"	29"	\$1,401

**23" D CONNECTING SIDE  
23" D EXTENSION  
46" D**

PART #	A	B	C	D	PRICE
FVECCWS.23465823L	23"	46"	58"	23"	\$877
FVECCWS.23465823R	23"	46"	58"	23"	\$877
FVECCWS.23464623L	23"	46"	64"	23"	\$987
FVECCWS.23464623R	23"	46"	64"	23"	\$987
FVECCWS.23467023L	23"	46"	70"	23"	\$1,009
FVECCWS.23467023R	23"	46"	70"	23"	\$1,009
FVECCWS.23467623L	23"	46"	76"	23"	\$1,229
FVECCWS.23467623R	23"	46"	76"	23"	\$1,229
FVECCWS.23468223L	23"	46"	82"	23"	\$1,378
FVECCWS.23468223R	23"	46"	82"	23"	\$1,378

**29" D CONNECTING SIDE  
29" D EXTENSION  
46" D**

PART #	A	B	C	D	PRICE
FVECCWS.29465829L	29"	46"	58"	29"	\$945
FVECCWS.29465829R	29"	46"	58"	29"	\$945
FVECCWS.29466429L	29"	46"	64"	29"	\$1,054
FVECCWS.29466429R	29"	46"	64"	29"	\$1,054
FVECCWS.29467029L	29"	46"	70"	29"	\$1,077
FVECCWS.29467029R	29"	46"	70"	29"	\$1,077
FVECCWS.29467629L	29"	46"	76"	29"	\$1,296
FVECCWS.29467629R	29"	46"	76"	29"	\$1,296
FVECCWS.29468229L	29"	46"	82"	29"	\$1,439
FVECCWS.29468229R	29"	46"	82"	29"	\$1,439

WORKSURFACE (MY-HITE)



## Ordering Verity Accessories & Storage

See below for a quick overview of the types of accessories and storage options available.

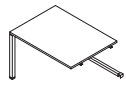

**Return Worksurfaces**



**Pedestals**



**Credenzas**



**Cabinets**



**Over-worksurface Storage**



**Fabric Tackboards**



**Glass Screens**

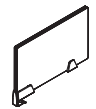

**Markerboards**



**Metal Shelves**

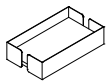

**Open Shelves**



**Monitor Arms**

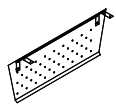

**Modesty Panels**

Accessories are available as either track-mounted, worksurface-mounted, or available in both.

Accessories	Track-Mounted	Worksurface-Mounted
Fabric Tackboard	X	X
Glass Screen	X	X
Markerboard		X
Metal Shelf	X	
Open Shelf	X	
Monitor Arm	X	
Modesty Panel		X

### Return Worksurface

Return Worksurfaces attach perpendicular to a worksurface either at the end of a run (A style attachment) or at the worksurface seam (B style attachment).

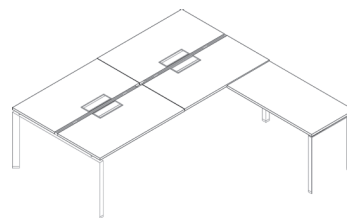

**A Style Attachment**  
at the end of a run

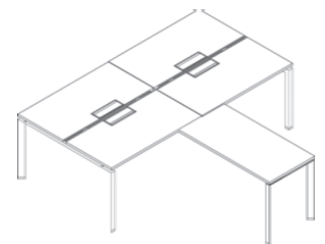

**B Style Attachment**  
at the worksurface seam

## Return Worksurface

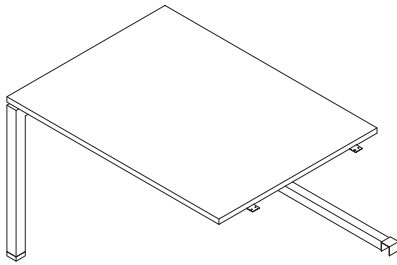

### A Style attachment shown

See page 75 for drawings of how to specify A style or B style return worksurfaces.

### DESCRIPTION

Attaches perpendicular to a worksurface, either at the end of a run (Attachment A) or at the worksurface seam (Attachment B).

Includes an open leg on one side, worksurface attachment bracket on the other, and worksurface without power/data grommet.

### NOTES

- Specify -A or -B style attachment.
- Cannot use A style attachment for:
  - 24"D Return Worksurface on a 48"W or 96"W Element.
  - 30"D Return Worksurface on a 54", 60", 66" or 72"W Element.
- Can be used with Start/End Elements or Extension Elements.

### SPECIFICATION OPTIONS

**product #:** see charts below  
**worksurface finish:** see page 8  
**edge finish:** see page 8  
**finish:** see page 8

### ORDER EXAMPLE

**product #:** FVRL.1836-A/B  
**worksurface finish:** M1 Light Maple  
**edge finish:** E1 Light Maple  
**finish:** CW Cloud White

### NOTES

Specify -A style for end of run attachment or -B style for worksurface seam attachment.

### NOTES

Specify -A style for end of run attachment or -B style for worksurface seam attachment.

- Cannot use A style attachment for:
- 24"D Return Worksurface on a 48"W or 96"W Element.

### NOTES

Specify -A style for end of run attachment or -B style for worksurface seam attachment.

- Cannot use A style attachment for:
- 30"D Return Worksurface on a 54", 60", 66" or 72"W Element.

### NOTES

B style attachment only.

### 18" DEPTH

PART #	HEIGHT	WIDTH	DEPTH	WT. (LBS)	LIST
FVRL.1836-A/B	—	36"	18"		\$739
FVRL.1842-A/B	—	42"	18"		\$767
FVRL.1848-A/B	—	48"	18"		\$795
FVRL.1854-A/B	—	54"	18"		\$858
FVRL.1860-A/B	—	60"	18"		\$954

### 24" DEPTH

PART #	HEIGHT	WIDTH	DEPTH	WT. (LBS)	LIST
FVRL.2436-A/B	—	36"	24"		\$799
FVRL.2442-A/B	—	42"	24"		\$835
FVRL.2448-A/B	—	48"	24"		\$910
FVRL.2454-A/B	—	54"	24"		\$1,010
FVRL.2460-A/B	—	60"	24"		\$1,046

### 30" DEPTH

PART #	HEIGHT	WIDTH	DEPTH	WT. (LBS)	LIST
FVRL.3036-A/B	—	36"	30"		\$906
FVRL.3042-A/B	—	42"	30"		\$924
FVRL.3048-A/B	—	48"	30"		\$993
FVRL.3054-A/B	—	54"	30"		\$1,176
FVRL.3060-A/B	—	60"	30"		\$1,221

### 36" DEPTH

PART #	HEIGHT	WIDTH	DEPTH	WT. (LBS)	LIST
FVRL.3636-A/B	—	36"	36"		\$957
FVRL.3642-A/B	—	42"	36"		\$1,011
FVRL.3648-A/B	—	48"	36"		\$1,062
FVRL.3654-A/B	—	54"	36"		\$1,253
FVRL.3660-A/B	—	60"	36"		\$1,306

## Mobile Pedestals Laminate

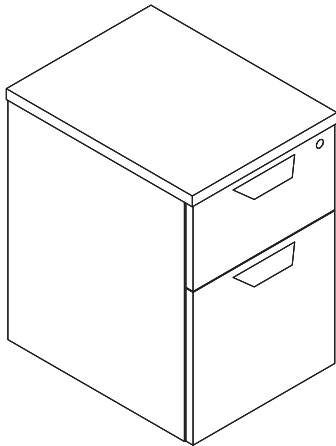

### DESCRIPTION

Mobile pedestals. Please view individual product details below.

### SPECIFICATION OPTIONS

**product #:** see charts below  
**front finish:** see page 8  
**worksurface finish:** see page 8  
**casing finish:** See page 8

### NOTES

- Cannot be used to support the worksurface
- Specify front, worksurface, casing, & pull when ordering.
- Includes pencil tray in top drawer

### ORDER EXAMPLES

**product #:** FD-BF-2016-MOB  
**front finish:** M1 Light Maple  
**worksurface finish:** M1 Light Maple  
**casing finish:** M29 Raven  
**pull:** Wedge, brushed aluminum

### PEDESTAL PULL OPTIONS



**Wedge Pull**  
 • Brushed Aluminum  
 • Black Umber

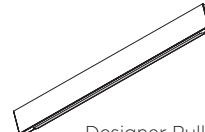

**Designer Pull**  
 • Cloud White/Red  
 • Cloud White/Green  
 • Cloud White/Grey

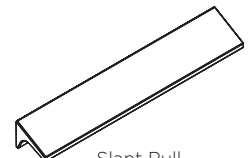

**Slant Pull**  
 • Brushed Aluminum  
 • Black Umber

### LAMINATE MOBILE BOX/FILE PEDESTAL

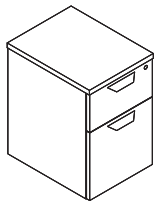

PART #	HEIGHT	WIDTH	DEPTH	LIST	NOTES
FD-BF-2016-MOB	24"	15.5"	20"	\$1,536	<ul style="list-style-type: none"> <li>• Locking mobile laminate pedestal with (2) drawers, pencil tray and pulls.</li> <li>• Specify front, worksurface, casing &amp; pull when ordering.</li> <li>• Includes pencil tray in top drawer</li> </ul>
FD-BF-2416-MOB	24"	15.5"	24"	\$1,582	

### LAMINATE MOBILE PENCIL/BOX/FILE PEDESTAL

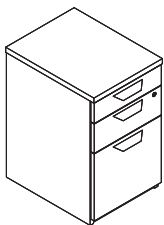

PART #	HEIGHT	WIDTH	DEPTH	LIST	NOTES
FD-PBF-2016-MOB	24.5"	15.5"	20"	\$1,952	<ul style="list-style-type: none"> <li>• Locking mobile laminate pedestal with (3) drawers, pencil tray and pulls.</li> <li>• Specify front, worksurface, casing &amp; pull when ordering.</li> <li>• Includes pencil tray in top drawer</li> </ul>

### BOX/FILE MOBILE LAMINATE PEDESTAL CUSHION

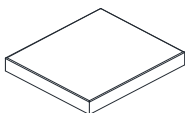

PART #	HEIGHT	WIDTH	DEPTH	LIST	NOTES
FD-BF-2016.CUSH	1.75"	15.5"	20"	\$397	<p><b>For laminate mobile box/file pedestal only.</b></p> <p><b>Note:</b> If cushion is placed on a full height mobile pedestal, it will not fit under a worksurface.</p> <p><b>Passage and Terrain</b> fabrics cannot be used on pedestal cushions (see page 6)</p> <p>COM is an option. (see page 6)</p>
FD-BF-2416.CUSH	1.75"	15.5"	24"	\$498	

**Mobile Pedestals** Metal

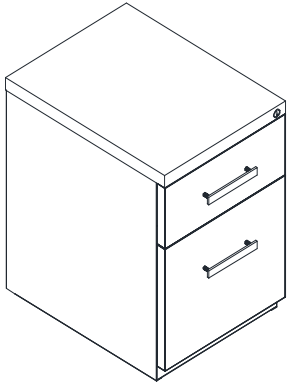

DESCRIPTION

Mobile pedestals. Please view individual product details below.

SPECIFICATION OPTIONS

**product #:** see charts below  
**finish:** see page 8  
**fabric cushion (optional):** see page 6  
**pull:** See page 9

NOTES

- Cannot be used to support the worksurface
- Specify pull when ordering (page 9)
- Includes pencil tray in top drawer

ORDER EXAMPLES

**product #:** FPEDSQP.BF-MOB-MET  
**finish:** CW Cloud White  
**fabric cushion (optional):** PF401-1 Silky-Natural  
**pull:** Wedge \$50 (see upcharge below)

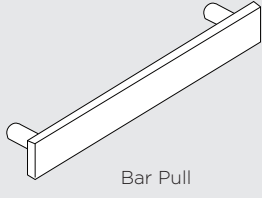
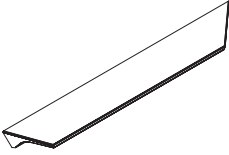
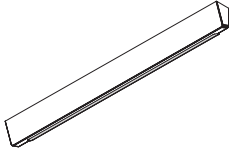
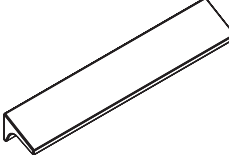
	DEFAULT PULL	PREMIUM PULLS (REQUIRE UPCHARGE ON METAL STORAGE)		
PEDESTAL PULL OPTIONS	 Bar Pull			
		Wedge Pull • Brushed Aluminum • Black Umber	Designer Pull • Cloud White/Red • Cloud White/Green • Cloud White/Grey	Slant Pull • Brushed Aluminum • Black Umber

**METAL MOBILE BOX/FILE PEDESTAL**

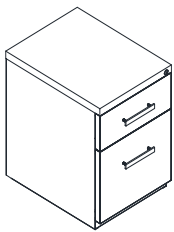

PART #	HEIGHT	WIDTH	DEPTH	WT. (LBS)	LIST
FPEDSQP.BF-MOB-MET	22"	15"	20"	85	\$912
WEDGE, DESIGNER OR SLANT PULL					+ \$50

NOTES

- Locking mobile metal pedestal with square front, pencil tray and pulls.
- Specify paint finish
- Specify pull when ordering
- Includes pencil tray in top drawer

**BOX/FILE MOBILE METAL PEDESTAL CUSHION**

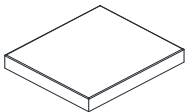

PART #	HEIGHT	WIDTH	DEPTH	WT. (LBS)	LIST
FPEDSQ.CUSH	1.75"	15"	20"	—	\$416

NOTES

For FPEDSQP.BF-MOB-MET metal mobile box/file pedestal only.  
 Passage and Terrain fabrics cannot be used on pedestal cushions. (See page 6)

**SIDE-TO-SIDE FILE BARS**

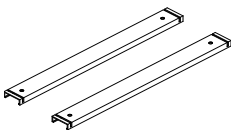

PART #	HEIGHT	WIDTH	DEPTH	WT. (LBS)	LIST
FSSB	—	—	—	1	\$18

NOTES

Side-to-side File Bars for filing letter or legal size folders.  
 Order one per file drawer  
 Finish: Black  
 Metal only

## Mobile Pedestals My-Hite

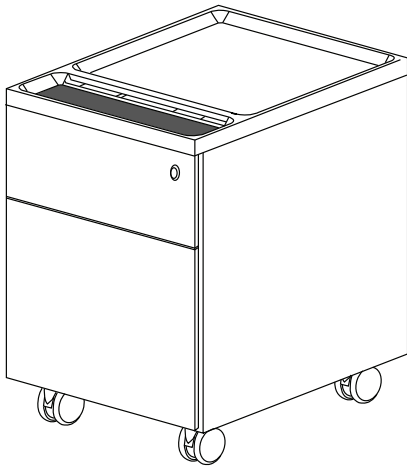

DESCRIPTION

Box/File mobile pedestal with lock and matching color top

SPECIFICATION OPTIONS

**product #:** FBFPED.MOB  
**finish:** CW, BU, SV  
**foam color (if applicable):** Charcoal, Café, Grey, and Red

NOTES

- Optional Foam cushion available
- Optional different color top available
- Foam cushion is available in 6 colors
- Key-alike available
- Changeable colored top available

ORDER EXAMPLE

**Pedestal:**  
**product #:** FBFPED.MOB  
**finish:** SV Silver  
**Cushion:**  
**product #:** FBFPED.CUSH  
**finish:** Charcoal

### MOBILE PEDESTAL

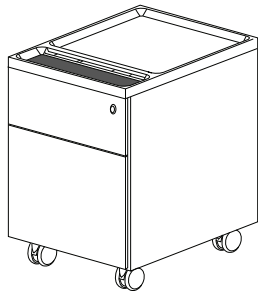

PART #	HEIGHT	WIDTH	DEPTH	WT. (LBS)	PRICE	NOTES
FBFPED.MOB	21.5"	15"	19 3/4"		\$761	<ul style="list-style-type: none"> <li>• Finish options: SV Silver, CW Cloud White and BU Black Umber</li> </ul>

### COLOR PEDESTAL TOP

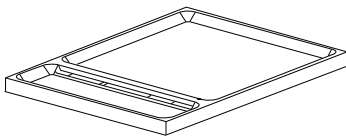

PART #	HEIGHT	WIDTH	DEPTH	PRICE	NOTES
FBFPED.PT				\$95	<ul style="list-style-type: none"> <li>• For use with FBFPED.MOB pedestal only</li> <li>• Color options: Green, Blue, and Red</li> <li>• Please select color when ordering</li> </ul>

### FOAM CUSHION

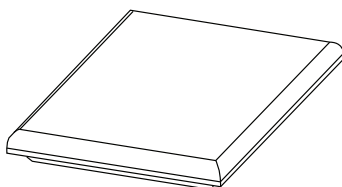

PART #	HEIGHT	WIDTH	DEPTH	WT. (LBS)	PRICE	NOTES
FBFPED.CUSH					\$159	<ul style="list-style-type: none"> <li>• For use with FBFPED.MOB pedestal only</li> <li>• Color options: Charcoal, Café, Grey, and Red</li> <li>• Please select color when ordering</li> <li>• Cushion is made of foam and not fabric covered</li> </ul>

## Credenzas

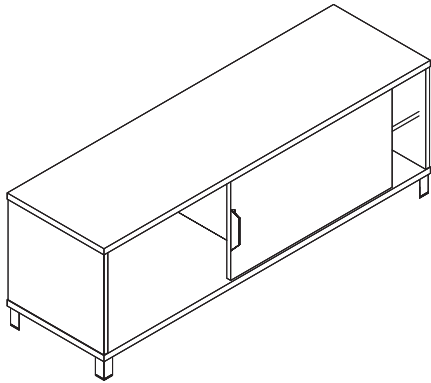

### DESCRIPTION

Laminate storage credenzas with open shelves and sliding doors with pull.

### NOTES

- Specify: Top, Front, Case, Pull & Foot.
- Pulls have color options: specify color when ordering. (See page 9)
- Specify L for left or R for right indicating door pull location.

### SPECIFICATION OPTIONS

**product #:** see charts below  
**front finish:** see page 6  
**top finish:** see page 6  
**casing finish:** see page 6  
**pull:** See page 9  
**foot finish:** BU, CW, SV

### ORDER EXAMPLE

**product #:** FVBSC.1860  
**front finish:** M1 Light Maple  
**top finish:** M1 Light Maple  
**casing finish:** M29 Raven  
**pull:** Wedge, brushed aluminum  
**foot finish:** CW

### CREDENZA PULL OPTIONS



**Wedge Pull**  
 • Brushed Aluminum  
 • Black Umber

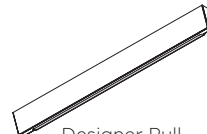

**Designer Pull**  
 • Cloud White/Red  
 • Cloud White/Green  
 • Cloud White/Grey

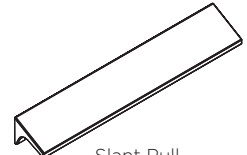

**Slant Pull**  
 • Brushed Aluminum  
 • Black Umber

### CREDENZA

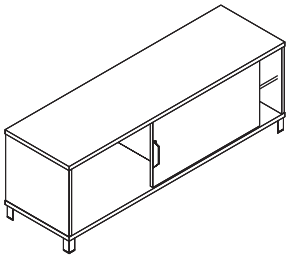

(Left Handed Shown)

PART #	HEIGHT	WIDTH	DEPTH	WT. (LBS)	LIST	NOTES
FVBSC.1848L	21.25"	48"	17.75"	—	\$1,473	Specify L for left or R for right indicating door pull location
FVBSC.1848R	21.25"	48"	17.75"	—	\$1,473	
FVBSC.1860L	21.25"	60"	17.75"	—	\$1,667	May also be specified as worksurface-supporting credenza. See Supporting Storage section for details.
FVBSC.1860R	21.25"	60"	17.75"	—	\$1,667	
FVBSC.1872L	21.25"	72"	17.75"	—	\$1,923	Specify: Top, Front, Case, Pull & Foot Finish
FVBSC.1872R	21.25"	72"	17.75"	—	\$1,923	

Credenzas continued

**MOBILE  
CREDENZA,  
36" WIDE**

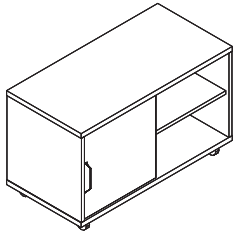

(Left Handed Shown)

PART #	HEIGHT	WIDTH	DEPTH	WT. (LBS)	LIST
FVBCMOB.1836L	21.75"	36"	17.75"	—	\$1,057
FVBCMOB.1836R	21.75"	36"	17.75"	—	\$1,057

**NOTES**

---

Mobile storage credenza with sliding door and pull

Specify: Top, Front, Case, & Pull

Specify L for left or R for right indicating door pull location.

**CREDENZA CUSHION**

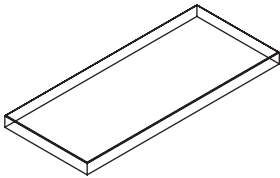

PART #	HEIGHT	WIDTH	DEPTH	WT. (LBS)	LIST
FCREDSQ.CUSH30	1.75"	30"	18"	—	\$429
FCREDSQ.CUSH36	1.75"	36"	18"	—	\$437
FCREDSQ.CUSH42	1.75"	42"	18"	—	\$493
FCREDSQ.CUSH48	1.75"	48"	18"	—	\$549
FCREDSQ.CUSH60	1.75"	60"	18"	—	\$658
FCREDSQ.CUSH72	1.75"	72"	18"	—	\$841

**NOTES**

---

Specify standard fabric.

**Passage and Terrain fabrics cannot be used on credenza cushions.** (See page 6)

May use shorter cushion on supporting credenza.

Example:

- Credenza 60" W, with 30" W cushion so credenza can support element. (See page 80)

## Cabinets

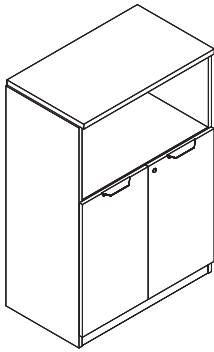

**DESCRIPTION**

Locking laminate storage cabinet with open shelf and doors with pulls.

**SPECIFICATION OPTIONS**

**product #:** see charts below  
**front finish:** see page 6  
**top finish:** see page 6  
**casing finish:** see page 6  
**door finish:** See page 6  
**pull:** See page 9

**NOTES**

- Specify: Top, Door, Case, Pull
- Pulls have color options: specify color when ordering. (See page 9)

**ORDER EXAMPLE**

**product #:** FVST.1824  
**front finish:** M1 Light Maple  
**top finish:** M1 Light Maple  
**casing finish:** M29 Raven  
**door finish:** M29 Raven  
**pull:** Wedge, brushed aluminum

**CABINET PULL OPTIONS**

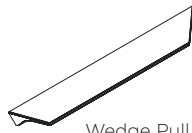

**Wedge Pull**  
 • Brushed Aluminum  
 • Black Umber

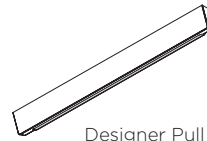

**Designer Pull**  
 • Cloud White/Red  
 • Cloud White/Green  
 • Cloud White/Grey

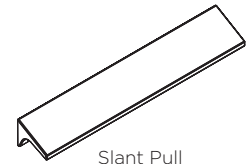

**Slant Pull**  
 • Brushed Aluminum  
 • Black Umber

### FREESTANDING STORAGE CABINET

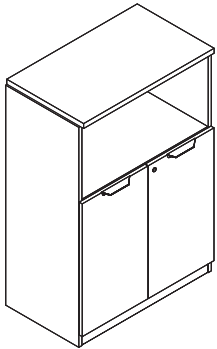

PART #	HEIGHT	WIDTH	DEPTH	WT. (LBS)	LIST	NOTES
FVST.1824	45"	24"	17.75"	—	\$1,336	Fixed open shelf above
FVST.1830	45"	30"	17.75"	—	\$1,505	Adjustable shelf behind, locking swing doors
FVST.1836	45"	36"	17.75"	—	\$1,749	Does not support worksurfaces Specify: Top, Door, Case & Pull



## Over-Worksurface Storage, Single-Sided

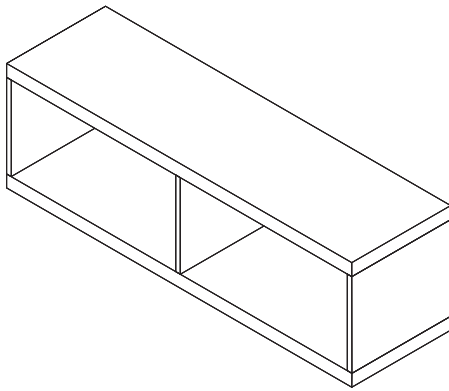

### DESCRIPTION

Single-sided laminate storage that is mounted above the worksurface, perpendicular to the spine. Available with open shelf or sliding door.

### NOTES

- Specify support (post leg or cabinet) separately
- Specify front finish and left/right pull location for storage door (if applicable)
- Specify pull when ordering
- Pulls have color options: specify color when ordering. (See page 9)

### SPECIFICATION OPTIONS

**product #:** see charts below  
**front finish:** see page 8  
**top finish:** see page 8  
**casing finish:** see page 8  
**finish:** CW, BU, SV  
**pull (if applicable):** See page 9

### ORDER EXAMPLE

**product #:** FVOSDSN.1524  
**front finish:** M1 Light Maple  
**top finish:** M1 Light Maple  
**casing finish:** M1 Light Maple  
**finish:** CW, Cloud White  
**pull (if applicable):** Wedge, brushed aluminum

### STORAGE PULL OPTIONS



**Wedge Pull**  
 • Brushed Aluminum  
 • Black Umber

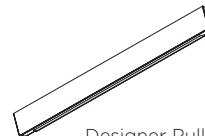

**Designer Pull**  
 • Cloud White/Red  
 • Cloud White/Green  
 • Cloud White/Grey

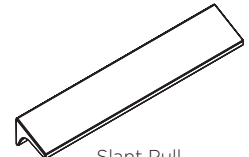

**Slant Pull**  
 • Brushed Aluminum  
 • Black Umber

### WITH SLIDING DOOR 15" HIGH

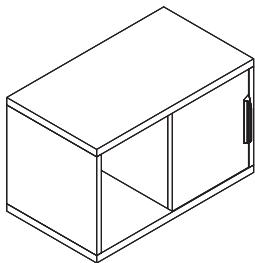

right hand shown

PART #	HEIGHT	WIDTH	DEPTH	WT. (LBS)	LIST	NOTES
FVOSDSN.1524L	15"	24"	13.75"	—	\$740	Laminate storage with sliding door and solid back
FVOSDSN.1524R	15"	24"	13.75"	—	\$740	
FVOSDSN.1530L	15"	30"	13.75"	—	\$817	Specify L for left or R for right indicating door pull location.
FVOSDSN.1530R	15"	30"	13.75"	—	\$817	
FVOSDSN.1548L	15"	48"	13.75"	—	\$1,070	Specify front finish for sliding door
FVOSDSN.1548R	15"	48"	13.75"	—	\$1,070	
FVOSDSN.1560L	15"	60"	13.75"	—	\$1,381	Specify pull when ordering
FVOSDSN.1560R	15"	60"	13.75"	—	\$1,381	
FVOSDSN.1572L	15"	72"	13.75"	—	\$1,499	
FVOSDSN.1572R	15"	72"	13.75"	—	\$1,499	

**Over-Worksurface Storage, Single-Sided** continued

**WITH OPEN SHELF  
15" HIGH**

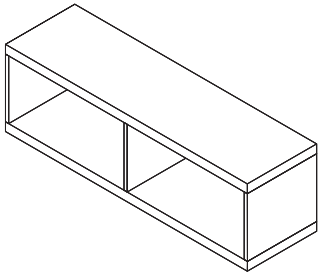

PART #	HEIGHT	WIDTH	DEPTH	WT. (LBS)	LIST
FVOSOSN.1524	15"	24"	13.75"	—	\$402
FVOSOSN.1530	15"	30"	13.75"	—	\$525
FVOSOSN.1548	15"	48"	13.75"	—	\$730
FVOSOSN.1560	15"	60"	13.75"	—	\$855
FVOSOSN.1572	15"	72"	13.75"	—	\$967

NOTES
Laminate storage with open shelf, and solid back
24"W and 30"W do not have a center divider.
48"W or wider have a center divider.

**WITH OPEN SHELF  
8" HIGH**

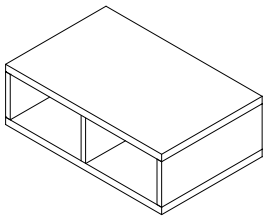

PART #	HEIGHT	WIDTH	DEPTH	WT. (LBS)	LIST
FVOSOS.0824	8"	24"	13.75"	—	\$268
FVOSOS.0830	8"	30"	13.75"	—	\$313
FVOSOS.0848	8"	48"	13.75"	—	\$491
FVOSOS.0860	8"	60"	13.75"	—	\$577
FVOSOS.0872	8"	72"	13.75"	—	\$655

NOTES
Laminate storage with open shelf, open back and center divider.
24"W and 30"W do not have a center divider.
48"W or wider have a center divider.

## Over-Worksurface Storage, Double-Sided

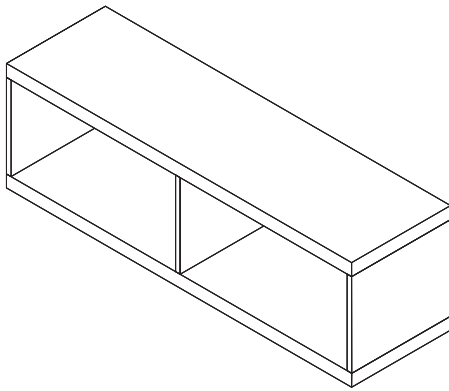

### DESCRIPTION

Double-sided (shared) storage that is mounted above the worksurface, perpendicular to the spine. Available with open shelf, or sliding door and markerboard.

### NOTES

- Specify support (post leg or cabinet) separately
- Specify front finish and left/right pull location for storage door (if applicable)
- Specify pull when ordering
- Pulls have color options: specify color when ordering. (See page 9)

### SPECIFICATION OPTIONS

**product #:** see charts below  
**front finish:** see page 8  
**top finish:** see page 8  
**casing finish:** see page 8  
**finish:** CW, BU, SV  
**pull (if applicable):** See page 9

### ORDER EXAMPLE

**product #:** FVOSDSH.1524  
**front finish:** M1 Light Maple  
**top finish:** M1 Light Maple  
**casing finish:** M1 Light Maple  
**finish:** CW, Cloud White  
**pull (if applicable):** Wedge, brushed aluminum

### STORAGE PULL OPTIONS



**Wedge Pull**  
 • Brushed Aluminum  
 • Black Umber

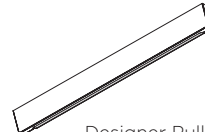

**Designer Pull**  
 • Cloud White/Red  
 • Cloud White/Green  
 • Cloud White/Grey

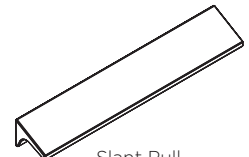

**Slant Pull**  
 • Brushed Aluminum  
 • Black Umber

### WITH SLIDING DOOR 15" HIGH

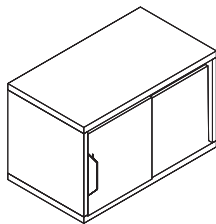

left hand shown

PART #	HEIGHT	WIDTH	DEPTH	WT. (LBS)	LIST	NOTES
FVOSDSH.1524L	15"	24"	13.75"	—	\$1,184	Laminate storage with sliding door and markerboard on each side
FVOSDSH.1524R	15"	24"	13.75"	—	\$1,184	
FVOSDSH.1530L	15"	30"	13.75"	—	\$1,318	Specify L for left or R for right indicating door pull location.
FVOSDSH.1530R	15"	30"	13.75"	—	\$1,318	
FVOSDSH.1548L	15"	48"	13.75"	—	\$1,761	Specify front finish for sliding door.
FVOSDSH.1548R	15"	48"	13.75"	—	\$1,761	
FVOSDSH.1560L	15"	60"	13.75"	—	\$2,025	Specify pull when ordering
FVOSDSH.1560R	15"	60"	13.75"	—	\$2,025	
FVOSDSH.1572L	15"	72"	13.75"	—	\$2,229	Premium pulls have color options: specify color when ordering. (See page 9)
FVOSDSH.1572R	15"	72"	13.75"	—	\$2,229	

**Over-Worksurface Storage, Double-Sided** continued

**WITH OPEN SHELF  
15" HIGH**

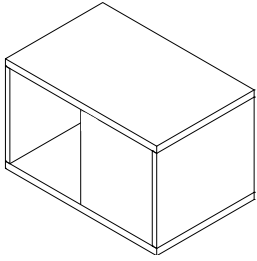

left hand shown

PART #	HEIGHT	WIDTH	DEPTH	WT. (LBS)	LIST
FVOSOSH.1524L	15"	24"	13.75"	—	\$362
FVOSOSH.1524R	15"	24"	13.75"	—	\$362
FVOSOSH.1530L	15"	30"	13.75"	—	\$362
FVOSOSH.1530R	15"	30"	13.75"	—	\$362
FVOSOSH.1548L	15"	48"	13.75"	—	\$602
FVOSOSH.1548R	15"	48"	13.75"	—	\$602
FVOSOSH.1560L	15"	60"	13.75"	—	\$652
FVOSOSH.1560R	15"	60"	13.75"	—	\$652
FVOSOSH.1572L	15"	72"	13.75"	—	\$728
FVOSOSH.1572R	15"	72"	13.75"	—	\$728

NOTES

Laminate storage with open shelf and markerboard on each side.  
Specify L for left or R for right indicating open shelf location.

**WITH OPEN SHELF  
8" HIGH**

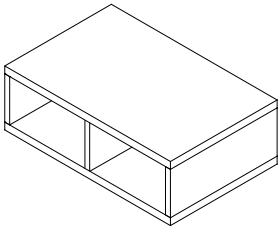

PART #	HEIGHT	WIDTH	DEPTH	WT. (LBS)	LIST
FVOSOS.0824	8"	24"	13.75"	—	\$268
FVOSOS.0830	8"	30"	13.75"	—	\$313
FVOSOS.0848	8"	48"	13.75"	—	\$491
FVOSOS.0860	8"	60"	13.75"	—	\$577
FVOSOS.0872	8"	72"	13.75"	—	\$655

NOTES

Laminate storage with open shelf, open back and center divider.  
24"W and 30"W do not have a center divider.  
48"W or wider have a center divider.

## Pulls Lateral

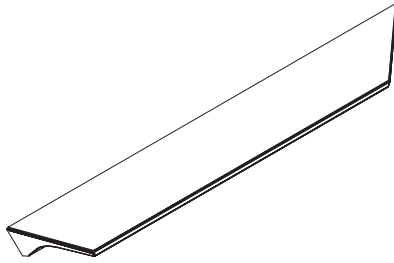

DESCRIPTION

3 different pull options to choose from

NOTES

- Pulls have color options: specify color when ordering. (See chart below)

SPECIFICATION OPTIONS

**product #:** see charts below  
**pull:** see charts below

ORDER EXAMPLE

**product #:** WEDGE-PULL-244  
**pull:** Wedge, brushed aluminum

### WEDGE PULL FOR LATERAL

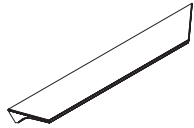

PART #	WT. (LBS)	LIST	NOTES
WEDGE-PULL-244	—	\$25	Wedge Pull for Lateral
WEDGE-PULL-244-BU	—	\$25	

### DESIGNER PULL FOR LATERAL

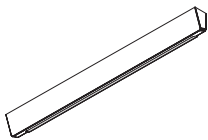

PART #	WT. (LBS)	LIST	NOTES
DESIGNER-PULL-250-RED	—	\$25	Designer Pull is CW (Cloud White) with non-slip color trim on underside. Trim available in 3 colors: Red, Green, and Grey
DESIGNER-PULL-250-GREEN	—	\$25	
DESIGNER-PULL-250-GREY	—	\$25	

### SLANT PULL FOR LATERAL

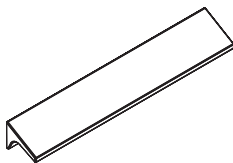

PART #	WT. (LBS)	LIST	NOTES
SLANT-PULL-199	—	\$25	Slant Pull for Lateral
SLANT-PULL-199-BU	—	\$25	

**Pulls Pedestal**

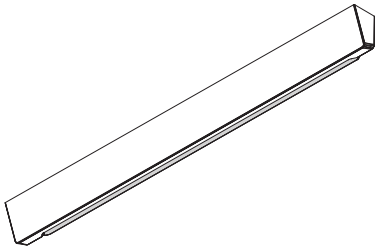

DESCRIPTION

3 different pull options to choose from

NOTES

- Pulls have color options: specify color when ordering. (See chart below)

SPECIFICATION OPTIONS

**product #:** see charts below  
**pull:** see charts below

ORDER EXAMPLE

**product #:** DESIGNER-PULL-250-RED  
**pull:** Designer Pull, RED

**WEDGE PULL FOR PEDESTAL**

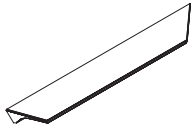

PART #	WT. (LBS)	LIST	NOTES
WEDGE-PULL-167	—	\$25	Wedge Pull for Pedestal
WEDGE-PULL-167-BU	—	\$25	

**DESIGNER PULL FOR PEDESTAL**

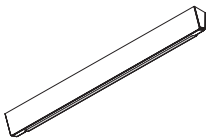

PART #	WT. (LBS)	LIST	NOTES
DESIGNER-PULL-250-RED	—	\$25	Designer Pull is CW (Cloud White) with non-slip color trim on underside. Trim available in 3 colors: Red, Green, and Grey
DESIGNER-PULL-250-GREEN	—	\$25	
DESIGNER-PULL-250-GREY	—	\$25	

**SLANT PULL FOR PEDESTAL**

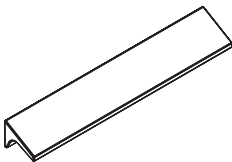

PART #	WT. (LBS)	LIST	NOTES
SLANT-PULL-167	—	\$25	Slant Pull for Pedestal
SLANT-PULL-167-BU	—	\$25	

## Support for Over-Worksurface Storage

DESCRIPTION

Supporting post leg or cabinet for over-worksurface mounted cabinets.

SPECIFICATION OPTIONS

**product #:** see charts below  
**top, casing and front finish:** see worksurface laminates on page 8

NOTES

- Specify top, casing and front finish for support cabinet.

ORDER EXAMPLE

**product #:** FVSL.3  
**finish:** CW Cloud White  
**product #:** FVSC.1416  
**front finish (if applicable):** M1 Light Maple

### SUPPORT COLUMN LEG WITH DISC BASE

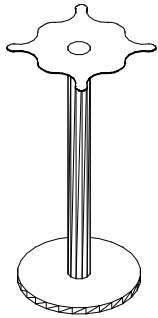

PART #	HEIGHT	WIDTH	DEPTH	WT. (LBS)	LIST
FVSL.3	29.5"	3"/14"	—	—	\$511

NOTES

Supporting column leg with disc base for over-worksurface mounted cabinets.

3"W column, 14"W disc base.

Supporting leg available in paint finish (page 8)

### SUPPORT CABINET

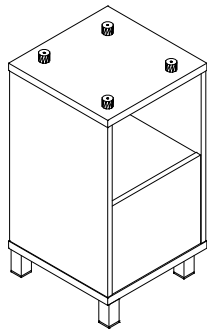

PART #	HEIGHT	WIDTH	DEPTH	WT. (LBS)	LIST
FVSC.1416	29.5"	15.5"	13.75"	—	\$1,058

NOTES

Supporting cabinet for over-worksurface mounted cabinets.

Specify top, casing and front finish

Opposite side is closed at top and open at bottom.

### SUPPORT CABINET, SINGLE SIDED

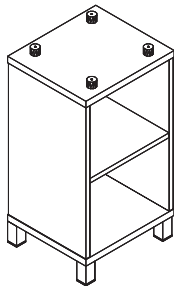

PART #	HEIGHT	WIDTH	DEPTH	WT. (LBS)	LIST
FVSCS.1416	29.5"	15.5"	13.75"	—	\$1,058

NOTES

Does not support worksurfaces

Specify: Top, Door, Case

## Track-Mounted Accessories, Fabric Tackboard

DESCRIPTION

Accessories mounted to the center track.  
Please view individual product details below.

SPECIFICATION OPTIONS

**product #:** see charts below  
**fabric (if applicable):** see page 6  
**(Passage and Terrain fabric not approved for this application)**  
**finish (if applicable):** see page 8  
**front finish (if applicable):** see page 8

NOTES

- Support brackets are available in Cloud White, Silver and Black Umber.
- A shelf cannot be installed in the same position as the track mounted tackboard.

**Passage and Terrain fabric not approved for this application**

ORDER EXAMPLE

**product #:** FVTKBDT.1536  
**fabric (if applicable):** PF401-1 Silky-Natural  
**product #:** FVDSS  
**finish (if applicable):** CW Cloud White  
**product #:** FVOSS.16  
**finish (if applicable):** CW Cloud White  
**front finish (if applicable):** CW Cloud White

### FABRIC TACKBOARD 15" (track-mounted)

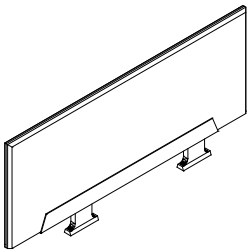

PART #	HEIGHT	WIDTH	DEPTH	WT. (LBS)	LIST
FVTKBDT.1536	15"	34"	1.25"	—	\$408
FVTKBDT.1542	15"	40"	1.25"	—	\$459
FVTKBDT.1548	15"	46"	1.25"	—	\$494
FVTKBDT.1554	15"	52"	1.25"	—	\$581
FVTKBDT.1560	15"	58"	1.25"	—	\$629
FVTKBDT.1566	15"	64"	1.25"	—	\$679
FVTKBDT.1572	15"	70"	1.25"	—	\$708

NOTES

Specify fabric on pg 6.

### FABRIC TACKBOARD 18" (track-mounted)

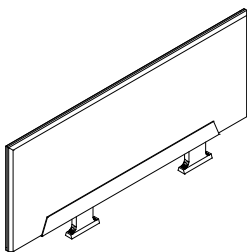

PART #	HEIGHT	WIDTH	DEPTH	WT. (LBS)	LIST
FVTKBDT.1836	18"	34"	1.25"	—	\$449
FVTKBDT.1842	18"	40"	1.25"	—	\$504
FVTKBDT.1848	18"	46"	1.25"	—	\$545
FVTKBDT.1854	18"	52"	1.25"	—	\$641
FVTKBDT.1860	18"	58"	1.25"	—	\$693
FVTKBDT.1866	18"	64"	1.25"	—	\$759
FVTKBDT.1872	18"	70"	1.25"	—	\$778

NOTES

Specify fabric on pg 6.  
Support brackets are available in Cloud White, Silver and Black Umber.  
Product is available for orders Feb. 1, 2017

### FABRIC TACKBOARD 20" (track-mounted)

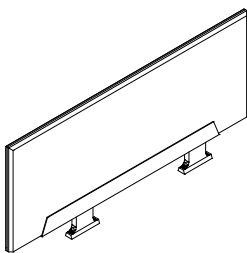

PART #	HEIGHT	WIDTH	DEPTH	WT. (LBS)	LIST
FVTKBDT.2036	20"	34"	1.25"	—	\$469
FVTKBDT.2042	20"	40"	1.25"	—	\$528
FVTKBDT.2048	20"	46"	1.25"	—	\$570
FVTKBDT.2054	20"	52"	1.25"	—	\$669
FVTKBDT.2060	20"	58"	1.25"	—	\$724
FVTKBDT.2066	20"	64"	1.25"	—	\$779
FVTKBDT.2072	20"	70"	1.25"	—	\$814

NOTES

Specify fabric on pg 6.  
Support brackets are available in Cloud White, Silver and Black Umber.  
Product is available for orders Feb. 1, 2017



## Track-Mounted Accessories, Glass Screen

### CLEAR GLASS SCREEN (track-mounted)

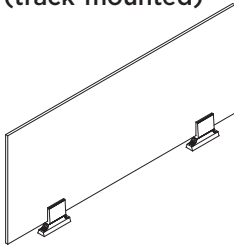

PART #	HEIGHT	WIDTH	DEPTH	WT. (LBS)	LIST
FVGSTCL.1524	15"	23.25"	1.25"	—	\$219
FVGSTCL.1530	15"	29.25"	1.25"	—	\$251
FVGSTCL.1536	15"	35.25"	1.25"	—	\$280
FVGSTCL.1542	15"	41.25"	1.25"	—	\$310
FVGSTCL.1548	15"	47.25"	1.25"	—	\$343
FVGSTCL.1554	15"	53.25"	1.25"	—	\$404
FVGSTCL.1560	15"	59.25"	1.25"	—	\$404
FVGSTCL.1566	15"	65.25"	1.25"	—	\$457
FVGSTCL.1572	15"	71.25"	1.25"	—	\$457

**NOTES**

---

Glass is clear.

For 78" tops, order 1 piece of 42" glass and 1 piece of 36" glass.

For 84" tops, order 2 pieces of 42" glass.

For 96" tops, order 2 pieces of 48" glass.

### FROSTED GLASS SCREEN (track-mounted)

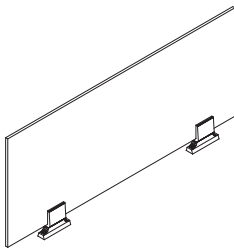

PART #	HEIGHT	WIDTH	DEPTH	WT. (LBS)	LIST
FVGSTFR.1524	15"	23.25"	1.25"	—	\$332
FVGSTFR.1530	15"	29.25"	1.25"	—	\$392
FVGSTFR.1536	15"	35.25"	1.25"	—	\$451
FVGSTFR.1542	15"	41.25"	1.25"	—	\$512
FVGSTFR.1548	15"	47.25"	1.25"	—	\$573
FVGSTFR.1554	15"	53.25"	1.25"	—	\$727
FVGSTFR.1560	15"	59.25"	1.25"	—	\$727
FVGSTFR.1566	15"	65.25"	1.25"	—	\$848
FVGSTFR.1572	15"	71.25"	1.25"	—	\$848

**NOTES**

---

Glass is frosted.

For 78" tops, order 1 piece of 42" glass and 1 piece of 36" glass.

For 84" tops, order 2 pieces of 42" glass.

For 96" tops, order 2 pieces of 48" glass.

### METAL SHELF (track-mounted)

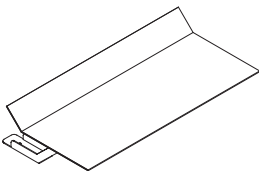

PART #	HEIGHT	WIDTH	DEPTH	WT. (LBS)	LIST
FVSS	5"	20"	6.75"	—	\$155

**NOTES**

---

Specify finish.

### OPEN SHELF (track-mounted)

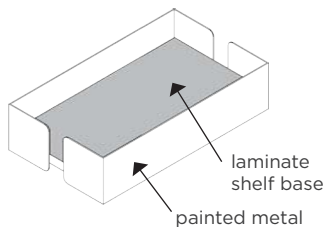

PART #	HEIGHT	WIDTH	DEPTH	WT. (LBS)	LIST
FVOSS.16	—	15.75"	—	—	\$275
FVOSS.22	—	21.5"	—	—	\$321

**NOTES**

---

Specify finish (painted metal) and front finish (lamine shelf base).

## Privacy Screen, Fabric

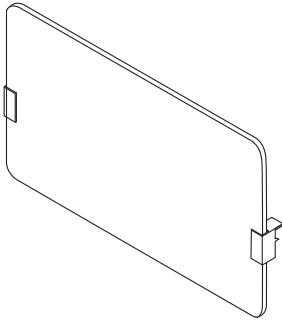

### DESCRIPTION

Work Surface mounted fabric covered privacy screen

### NOTES

Fabric screen is non-tackable  
 Actual screen is shorter than the worktop.  
 Example: FPSFLUSH.2448 for use on 46"/48" width table, actual width of screen is 40"  
 Fabric covered privacy screens have Black Reveal.  
**Passage and Terrain fabric not approved for this application.**

### SPECIFICATION OPTIONS

**product #:** see charts below  
**Paint (Brackets):** CW, BU, SV  
**fabric:** see page 6 (**Passage and Terrain fabric not approved for this application**)

### ORDER EXAMPLE

**product #:** FPSFLUSH.2442  
**brackets:** SV, Silver  
**fabric:** PF-101-1, Terrian, Caramel

### Fabric Privacy Screen - Flush

PART #	HEIGHT	WIDTH	LIST
FPSFLUSH.2442	24"	34"	\$651
FPSFLUSH.2448	24"	40"	\$704
FPSFLUSH.2454	24"	46"	\$758
FPSFLUSH.2460	24"	52"	\$814
FPSFLUSH.2466	24"	58"	\$870
FPSFLUSH.2472	24"	64"	\$925

### NOTES

- Privacy screen sits flush with the back of the worktop.
- Fabric covered privacy screens have Black Reveal.
- Privacy screen is 8" shorter than free standing top width and 6" shorter than a worksurface from a paneled system.

Example:

1. Actual width of FPSFLUSH.2460 is 52"

### Fabric Privacy Screen - with Wire Management Gap

PART #	HEIGHT	WIDTH	LIST
FPSGAP.2442	24"	34"	\$651
FPSGAP.2448	24"	40"	\$704
FPSGAP.2454	24"	46"	\$758
FPSGAP.2460	24"	52"	\$814
FPSGAP.2466	24"	58"	\$870
FPSGAP.2472	24"	64"	\$925

### NOTES

- Fabric covered privacy screens have Black Reveal.
- With 1" gap at back of worksurface for cord/wire management.

Example:

1. Actual width of FPSGAP.2460 is 52"

### Fabric Privacy Screen - Flush End-Of-Run with Triangle Leg

PART #	HEIGHT	WIDTH	LIST
FVPS.3948	39"	48"	\$929
FVPS.3960	39"	60"	\$1,053

### NOTES

- Fabric covered privacy screens have Black Reveal.  
 Privacy screen sits flush with the back of the worktop.
- Actual width of FVPS.3948 is 43"
  - Actual width of FVPS.3960 is 55"
  - Use with Triangle Legs only

### Fabric Privacy Screen - Flush End-Of-Run with Inset Legs or Taper Legs

PART #	HEIGHT	WIDTH	LIST
FVPS.3942	39"	36"	\$950
FVPS.3954	39"	48"	\$1,080

### NOTES

- Fabric covered privacy screens have Black Reveal.  
 Privacy screen sits flush with the back of the worktop.
- Actual width of FVPS.3942 is 36.5"
  - Actual width of FVPS.3954 is 48.75"
  - Use with Inset or Taper Legs only

## Privacy Screen, Marker Board

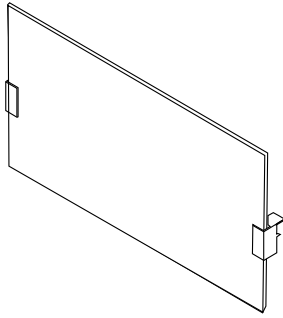

### DESCRIPTION

Work Surface mounted marker board privacy screen

### NOTES

To use a wire manager on your My-Hite table with a **marker board** privacy screen, you must order "with gap".

Marker board screen is writable on both sides

Actual screen is shorter than the worktop.

Example: FMPSFLUSH.2448 for use on 46"/48" width table, actual width of screen is 40"

### SPECIFICATION OPTIONS

**product #:** see charts below  
**Paint (Brackets):** CW, BU, SV

### ORDER EXAMPLE

**product #:** FMPSFLUSH.2442  
**brackets:** SV, Silver

### Marker Board Privacy Screen - Flush

PART #	HEIGHT	WIDTH	LIST
FMPSFLUSH.2442	24"	34"	\$787
FMPSFLUSH.2448	24"	40"	\$901
FMPSFLUSH.2454	24"	46"	\$1,015
FMPSFLUSH.2460	24"	52"	\$1,131
FMPSFLUSH.2466	24"	58"	\$1,245
FMPSFLUSH.2472	24"	64"	\$1,360

### NOTES

- Privacy screen sits flush with the back of the worktop.
- Privacy screen is 8" shorter than free standing top width and 6" shorter than a worksurface from a paneled system.

Example:

1. Actual width of FMPSFLUSH.2460 is 52"

### Marker Board Privacy Screen - with Wire Management Gap

PART #	HEIGHT	WIDTH	LIST
FMPSPGAP.2442	24"	34"	\$787
FMPSPGAP.2448	24"	40"	\$901
FMPSPGAP.2454	24"	46"	\$1,015
FMPSPGAP.2460	24"	52"	\$1,131
FMPSPGAP.2466	24"	58"	\$1,245
FMPSPGAP.2472	24"	64"	\$1,360

### NOTES

- With 1" gap at back of worksurface for cord/wire management.

Example:

1. Actual width of FMPSPGAP.2460 is 52"

## Privacy Screen, Laminate

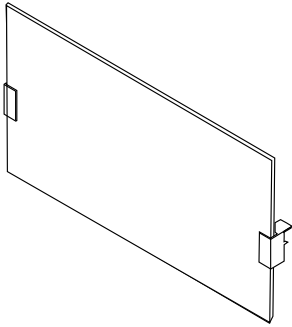

DESCRIPTION

Work Surface mounted laminate privacy screen

NOTES

To use a wire manager on your My-Hite table with a laminate privacy screen, you must order "with gap".

Actual screen is shorter than the worktop.

SPECIFICATION OPTIONS

**product #:** see charts below  
**Paint (Brackets):** CW, BU, SV  
**finish:** see page 8

ORDER EXAMPLE

**product #:** FLPSFLUSH.2442  
**brackets:** SV, Silver

### Laminate Privacy Screen - Flush

PART #	HEIGHT	WIDTH	LIST
FLPSFLUSH.2442	24"	34"	\$423
FLPSFLUSH.2448	24"	40"	\$472
FLPSFLUSH.2454	24"	46"	\$519
FLPSFLUSH.2460	24"	52"	\$566
FLPSFLUSH.2466	24"	58"	\$614
FLPSFLUSH.2472	24"	64"	\$661

NOTES

- Privacy screen sits flush with the back of the worktop.
- Privacy screen is 8" shorter than free standing top width and 6" shorter than a worksurface from a paneled system.

Example:

1. Actual width of FLPSFLUSH.2460 is 52"

### Laminate Privacy Screen - with Wire Management Gap

PART #	HEIGHT	WIDTH	LIST
FLPSGAP.2442	24"	34"	\$423
FLPSGAP.2448	24"	40"	\$472
FLPSGAP.2454	24"	46"	\$519
FLPSGAP.2460	24"	52"	\$566
FLPSGAP.2466	24"	58"	\$614
FLPSGAP.2472	24"	64"	\$661

NOTES

- With 1" gap at back of worksurface for cord/wire management.

Example:

1. Actual width of FPSGAP.2460 is 52"

## Modesty Panel, Laminate

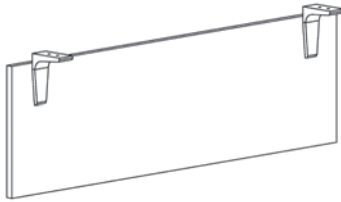

### DESCRIPTION

Laminate modesty panel with matching 2mm PVC edge

### SPECIFICATION OPTIONS

**product #:** see charts below  
**Paint (Brackets)** CW, BU, SV  
**Laminate (Modesty Panel)** see page 8

### ORDER EXAMPLE

**product #:** FLMOD.0836  
**paint:** CW, Cloud White  
**laminate:** M12, Medium Walnut

### Laminate Modesty Panel

PART #	HEIGHT	WIDTH	LIST
FLMOD.0836	8"	36"	\$255
FLMOD.0842	8"	42"	\$265
FLMOD.0848	8"	48"	\$272
FLMOD.0854	8"	54"	\$328
FLMOD.0860	8"	60"	\$411
FLMOD.0866	8"	66"	\$419
FLMOD.0872	8"	72"	\$428
FLMOD.0884	8"	84"	\$444
FLMOD.0896	8"	96"	\$460

### NOTES

- For use with single-sided units only.
- Modesty panel is actual width

FLMOD.1636	16"	36"	\$316
FLMOD.1642	16"	42"	\$323
FLMOD.1648	16"	48"	\$330
FLMOD.1654	16"	54"	\$436
FLMOD.1660	16"	60"	\$519
FLMOD.1666	16"	66"	\$526
FLMOD.1672	16"	72"	\$536
FLMOD.1684	16"	84"	\$551
FLMOD.1696	16"	96"	\$568

## Worksurface-Mounted Accessories, Fabric Tackboard

DESCRIPTION	SPECIFICATION OPTIONS
Accessories mounted to the worksurface.	<b>product #:</b> see charts below <b>fabric:</b> See page 6 ( <b>Passage and Terrain fabric not approved for this application</b> ). <b>finish:</b> See page 8
NOTES	ORDER EXAMPLE
<ul style="list-style-type: none"> <li><b>Passage and Terrain fabric not approved for this application</b></li> <li>Clamps to worksurface on one side</li> </ul>	<b>product #:</b> FVTKBDW.1522 <b>fabric:</b> PF401-1 Silky-Natural <b>finish:</b> CW Cloud White

### FABRIC TACKBOARD 15" (surface-mounted)

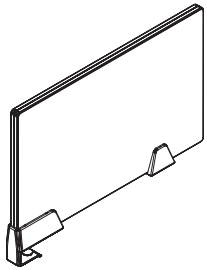

PART #	HEIGHT	WIDTH	DEPTH	WT. (LBS)	LIST
FVTKBDW.1522	15"	22"	1"	—	\$274
FVTKBDW.1528	15"	28"	1"	—	\$338

### FABRIC TACKBOARD 18" (surface-mounted)

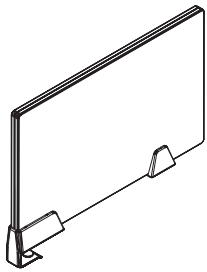

PART #	HEIGHT	WIDTH	DEPTH	WT. (LBS)	LIST
FVTKBDW.1822	18"	22"	1"	—	\$302
FVTKBDW.1828	18"	28"	1"	—	\$371

### FABRIC TACKBOARD 20" (surface-mounted)

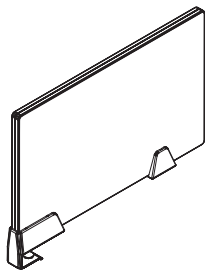

PART #	HEIGHT	WIDTH	DEPTH	WT. (LBS)	LIST
FVTKBDW.2022	20"	22"	1"	—	\$315
FVTKBDW.2028	20"	28"	1"	—	\$388

ACCESSORIES

## Worksurface-Mounted Accessories

### CLEAR GLASS SCREEN (surface-mounted)

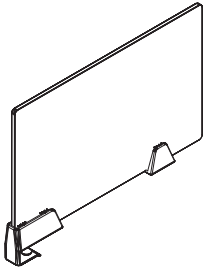

PART #	HEIGHT	WIDTH	DEPTH	WT. (LBS)	LIST
FVGSWCL.1522	15"	22"	1"	—	\$280
FVGSWCL.1528	15"	28"	1"	—	\$349

**NOTES**

---

Mounts along the worksurface.  
Glass is clear.  
Includes hardware.

### FROSTED GLASS SCREEN (surface-mounted)

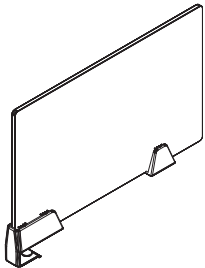

PART #	HEIGHT	WIDTH	DEPTH	WT. (LBS)	LIST
FVGSWFR.1522	15"	22"	1"	—	\$388
FVGSWFR.1528	15"	28"	1"	—	\$436

**NOTES**

---

Mounts along the worksurface.  
Glass is frosted.  
Includes hardware.

### MARKERBOARD SCREEN (surface-mounted)

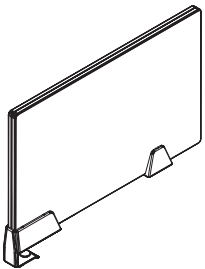

PART #	HEIGHT	WIDTH	DEPTH	WT. (LBS)	LIST
FVMKRW.1522	15"	22"	1"	—	\$383
FVMKRW.1528	15"	28"	1"	—	\$497

**NOTES**

---

Mounts along the worksurface.  
Markerboard with write and erase surface.  
Includes hardware.

### MODESTY PANEL (under surface-mounted)

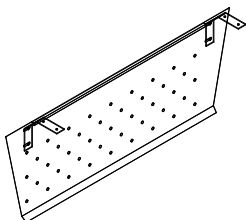

PART #	HEIGHT	WIDTH	DEPTH	WT. (LBS)	LIST
FVMOD.1648	13.75"	36"	1"	—	\$249
FVMOD.1654	13.75"	42"	1"	—	\$251
FVMOD.1660	13.75"	48"	1"	—	\$264
FVMOD.1666	13.75"	54"	1"	—	\$279
FVMOD.1672	13.75"	60"	1"	—	\$296
FVMOD.1678	13.75"	66"	1"	—	\$434

**NOTES**

---

For use with single-sided units only.  
Perforated metal modesty panel mounts under the worksurface.  
Specify paint finish.  
For a 96"W worksurface, order two 48" modesty panels.

**SUPPORTING BRACKETS**

For worksurface mounted fabric/markerboard screen

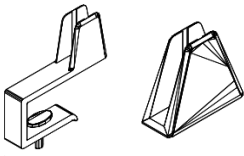

PART #	LIST	NOTES
FV - X	\$99	BU, CW, SV Finishes Supporting brackets for worksurface mounted fabric or Markerboard screen.

**SUPPORTING BRACKETS**

For worksurface mounted glass screen

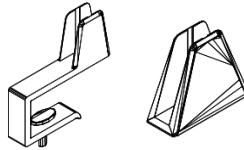

PART #	LIST	NOTES
FV-XT	\$99	BU, CW, SV Finishes Supporting brackets for worksurface mounted glass screen. For use with customers own material screen.

**DESK MOUNTED POWER UNIT - CLAMP**



PART #	LIST	NOTES
FPWR.DM	\$454	<ul style="list-style-type: none"> <li>Power unit clamps onto surface</li> <li>The power cord comes attached to the unit. The cord measures approximately 6 ft in length.</li> <li>Includes 3 plugs and 2 USB-A ports</li> <li>Distributes up to 10 amps</li> <li>Finish: available in BU and CW</li> </ul>

**DESK MOUNTED POWER UNIT - ADHESIVE**

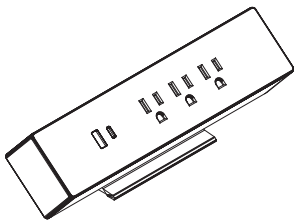

PART #	LIST	NOTES
FPWR.DM-2	\$454	<ul style="list-style-type: none"> <li>Power unit attaches to surface with adhesive</li> <li>The power cord comes attached to the unit. The cord measures approximately 6 ft in length.</li> <li>Includes 3 plugs, 1 USB-C and 1 USB-A port</li> <li>Distributes up to 10 amps</li> <li>Finish: available in BU and CW</li> </ul>

**MESH WIRE MANAGER**

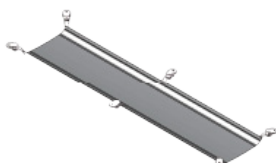

PART #	LENGTH	LIST	NOTES
FFWM.18	18"	\$159	<ul style="list-style-type: none"> <li>Wire manager mounts to the bottom of a worksurface to manage cords</li> <li>Finish: Black with red zipper</li> </ul>
FFWM.34	34"	\$159	



**SINGLE MONITOR ARM**



PART #	HEIGHT	WIDTH	DEPTH	WT. (LBS)	LIST	NOTES
FMA-S	—	—	—	—	\$688	<p>BU, CW, SV Finishes</p> <p>Includes attachment hardware for clamp, grommet and Verity track mount.</p> <p>Includes (2) USB ports, 6' cords</p>

**DUAL MONITOR ARM**



PART #	HEIGHT	WIDTH	DEPTH	WT. (LBS)	LIST	NOTES
FMA-D	—	—	—	—	\$982	<p>BU, CW, SV Finishes</p> <p>Includes attachment hardware for clamp, grommet and Verity track mount.</p> <p>Includes (2) USB ports, 6' cords</p> <p>Monitor arms cannot be placed directly over the power grommet. If double monitor arm is needed, we recommend two single arms placed to the right and left of the grommet.</p>

**Keyed-Alike Information**

SPECIFICATION OPTIONS

**product #:** see charts below

ORDER EXAMPLE

**product #:** LAMI-KEY-ALIKE-4

PART #	DESCRIPTION	PRICE	NOTES
LAM1-KEY-ALIKE-4	Lock Core Keyed-Alike (set of 4) - Type 1 Laminate Storage	\$192	<ul style="list-style-type: none"> <li>Laminate Key Cores are for use with laminate storage only. Cannot be keyed alike with metal storage.</li> <li>Keyed-Alike Lock Cores are sold in sets of 4 or 6.</li> <li>Each set of keyed alike cores includes the cores, each core has two keys and all cores are the same lock number.</li> <li>Lock core removal/change keys will need to be ordered separately.</li> <li>Specific lock numbers are unavailable.</li> </ul>
LAM1-KEY-ALIKE-6	Lock Core Keyed-Alike (set of 6) - Type 1 Laminate Storage	\$289	
LAM1-FCK	Lock Core Change Key - Type 1 Laminate Storage	\$28	
LAM1-FMK	Lock Core Master Key - Type 1 Laminate Storage	\$28	
LAM1-KEY-CORE	Single Lock Core - Type 1 Laminate Storage	\$38 each	

PART #	DESCRIPTION	PRICE	NOTES
METAL1-KEY-ALIKE-4	Lock Core Keyed-Alike (set of 4) - Type 1 Metal Storage	\$192	<ul style="list-style-type: none"> <li>All Friant Pedestals, Lateral Files, and Overhead Cabinets can be keyed-alike</li> <li>Metal key cores are for use with metal storage only. Cannot be keyed alike with laminate storage.</li> <li>Keyed-Alike Lock Cores are sold in sets of 4 or 6).</li> <li>Each set includes four Lock Cores, each with two keys, all with the same lock number.</li> <li>Lock core removal/change keys will need to be ordered separately.</li> <li>Additional Lock Core Removal Keys and Master Keys are available.</li> </ul>
METAL1-KEY-ALIKE-6	Lock Core Keyed-Alike (set of 6) - Type 1 Metal Storage	\$289	
METAL1-FCK	Lock Core Change Key - Type 1 Metal Storage	\$28	
METAL1-FMK	Lock Core Master Key - Type 1 Metal Storage	\$28	
METAL1-KEYBLANK	Key Blank - Type 1 Metal Storage	\$4	