

TABLES

PRICEBOOK

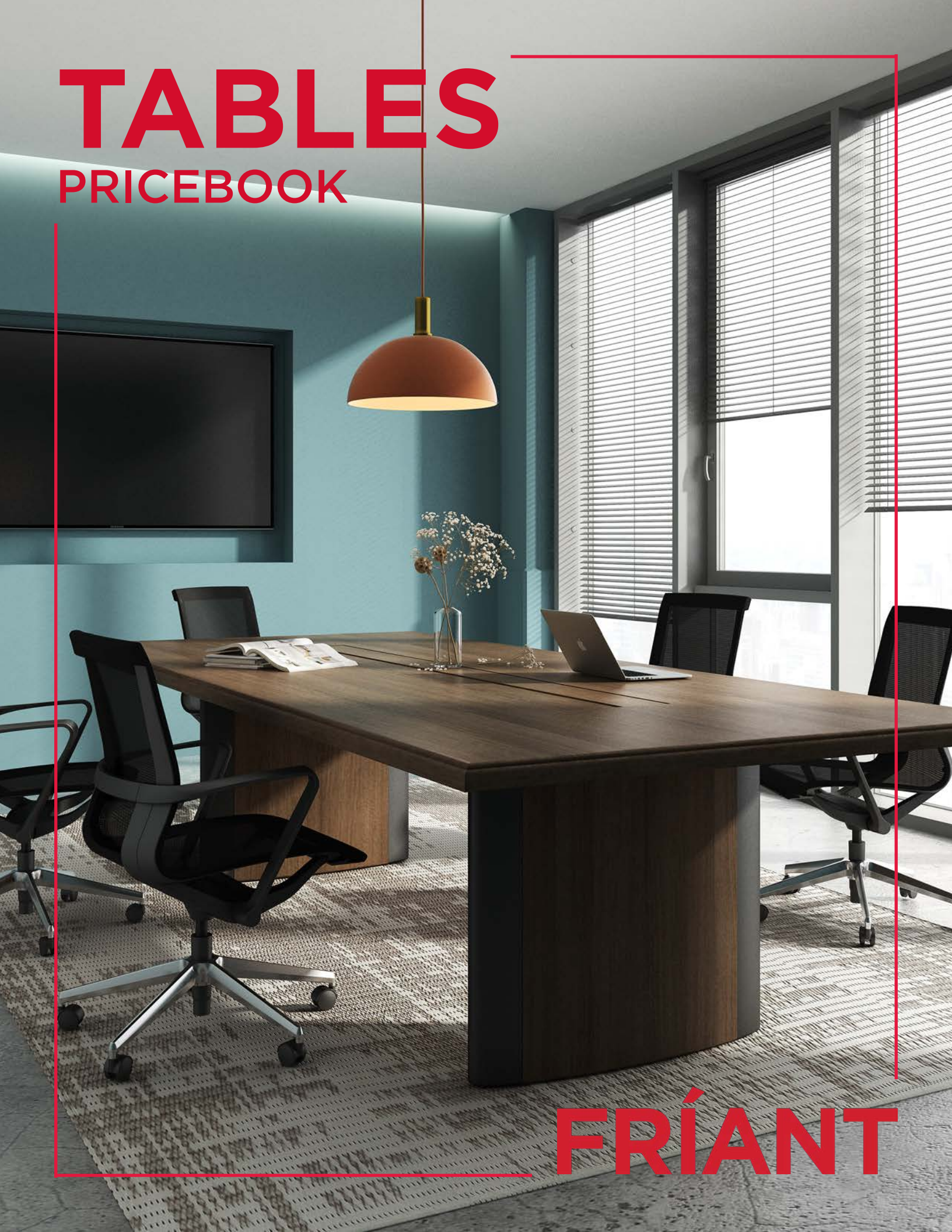

FRÍANT

TABLES

PRICEBOOK

LUNE

NESTING TABLES

Overview	3
Pricing	8
Finishes	10

SCOPE

OCCASIONAL TABLES

Overview	12
Pricing	17
Finishes	21

ROKE AND RAFFE

TABLES

Overview	23
Pricing	25
Finishes	26

METAL BASE

TABLES

Overview	27
Pricing	30
Finishes	36

MESA

CONFERENCE TABLES

Overview	38
Pricing	47
Finishes	48

TERMS & CONDITIONS	56
--------------------	----

LUNE

NESTING TABLES

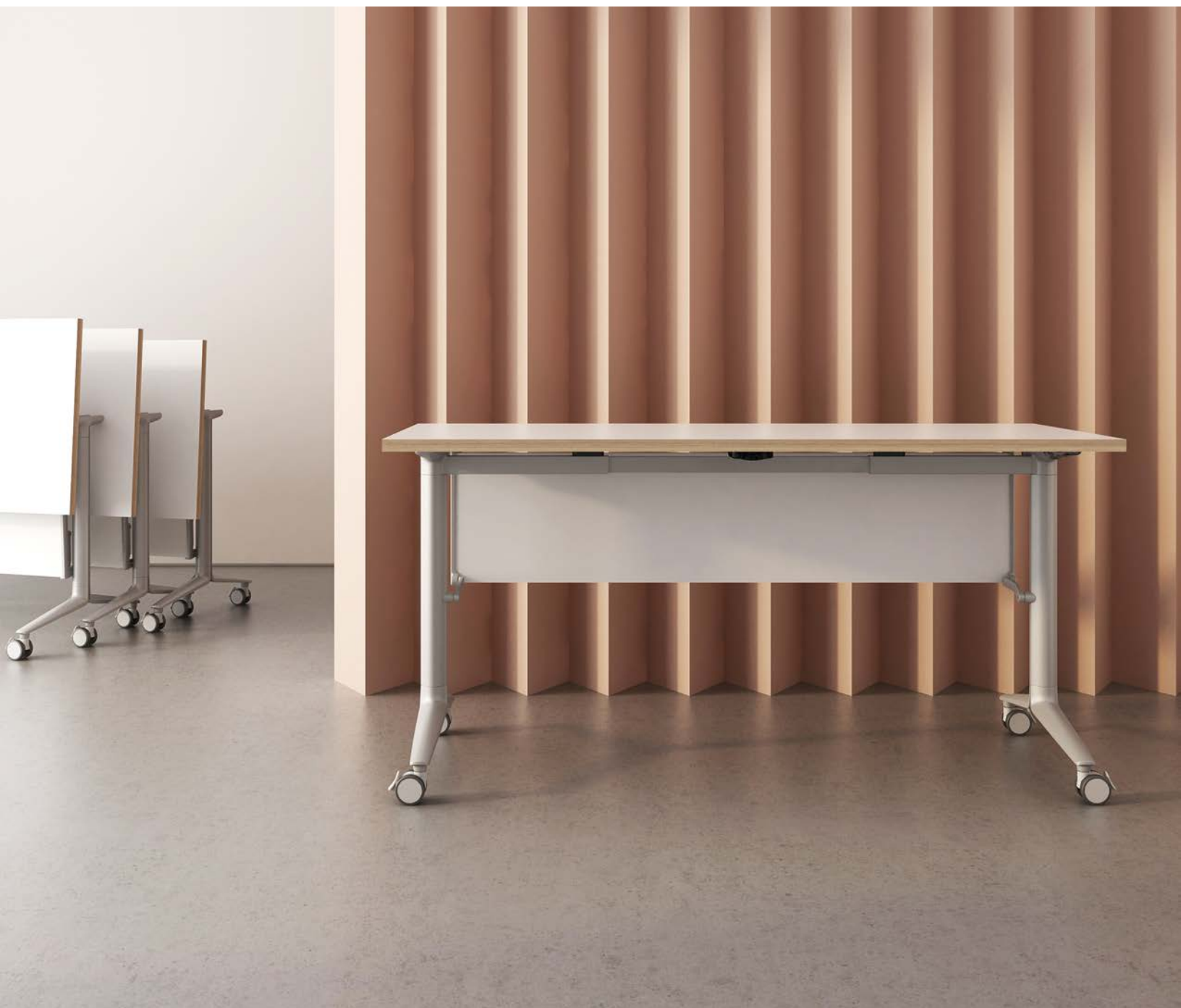

NESTING
TABLES
LUNE



FORM
FLEXIBILITY
FUNCTION

Versatile and mobile, Lune tables are easy to set-up and configure into a wide range of spaces. Rearrange and adapt on the fly. The flip-top mechanism enables you to make the most of your space, easily nesting tables for compact storage when not in use.

NESTING
TABLES
LUNE



Create dynamic spaces for people to learn, collaborate, and connect.

**LUNE and SOLEIL
THE PERFECT MATCH**

Soleil flip-up chairs on casters are the perfect accompaniment to Lune tables.

Find them in the Seating Catalog at friant.com

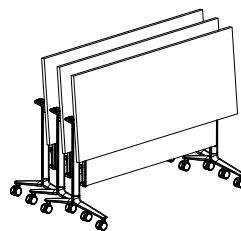
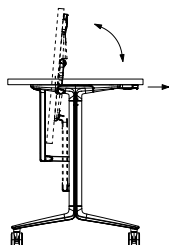
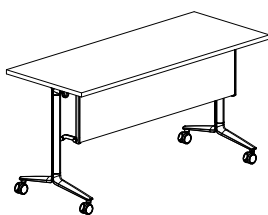

LUNE TABLE FEATURES AND FUNCTIONS

Easy to move, use and store.

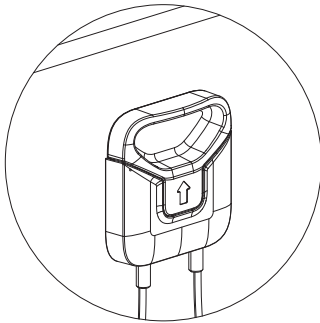

FLIP MECHANISM

Simple flip-top mechanism is designed for single-handed operation

OPTIONAL CONNECTING BRACKET

Link multiple tables together to adapt and reconfigure as needed

MODESTY PANEL

Available with and without modesty panel

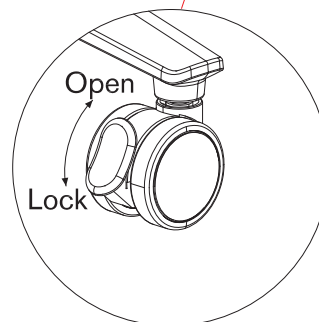
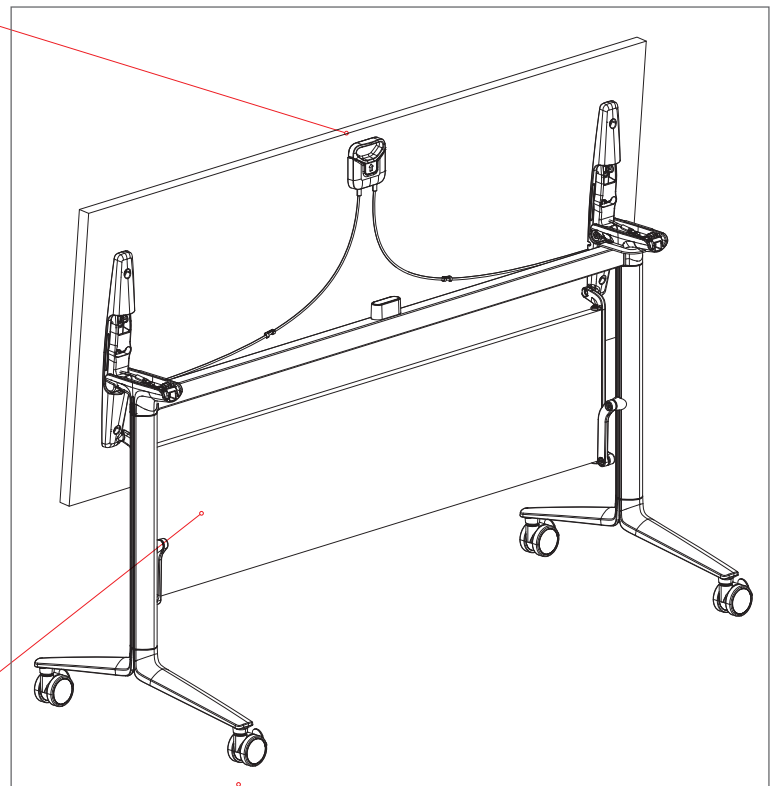

LOCKING CASTERS

Quickly and easily lock the table in place

ORDER LUNE IN 4 SIMPLE STEPS:

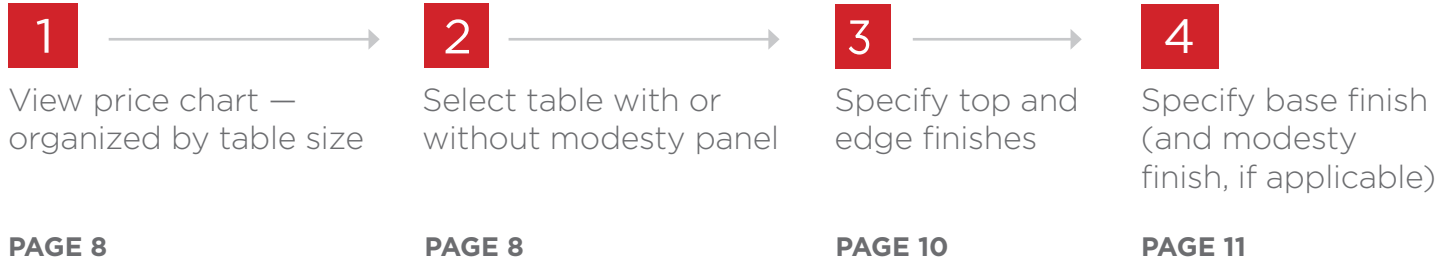

ANATOMY OF A PRODUCT NUMBER



Be sure to specify finishes and base options in the description of your order.

Example:

FCTTB-MOD.2460

Description:

Lune flip up nesting table on casters, with modesty panel, 24 x 60

Top Finish:	M13	Licorice
Edge Finish:	E13	Licorice
Finish:	GM	Gunmetal
Modesty Finish:	BU	Black Umber

LUNE TABLE WITHOUT MODESTY

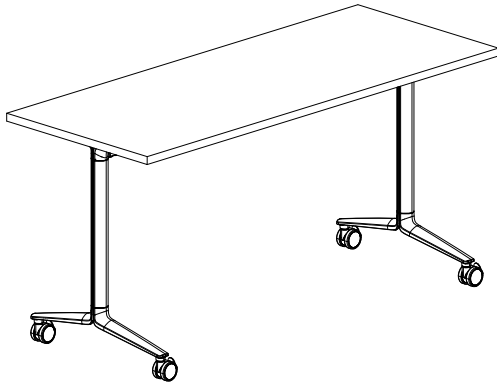

Model No.	Depth	Length	List
FCTTB.2048	20"	48"	\$1,822
FCTTB.2054	20"	54"	\$1,869
FCTTB.2060	20"	60"	\$1,874
FCTTB.2072*	20"	72"	\$1,937
FCTTB.2448	24"	48"	\$1,859
FCTTB.2454	24"	54"	\$1,906
FCTTB.2460	24"	60"	\$1,912
FCTTB.2472*	24"	72"	\$1,973
FCTTB.3048	30"	48"	\$1,869
FCTTB.3054	30"	54"	\$1,923
FCTTB.3060	30"	60"	\$1,928
FCTTB.3072*	30"	72"	\$1,993

* Contact Customer Success for lead time

LUNE TABLE WITH MODESTY

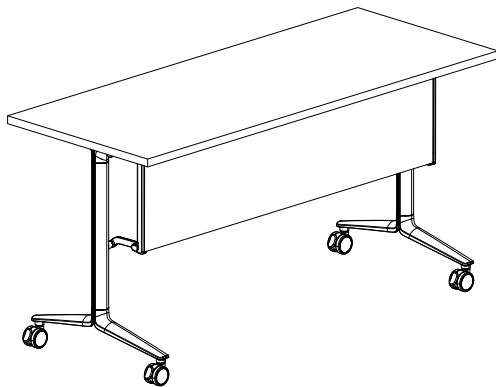

Model No.	Depth	Length	List
FCTTB-MOD.2048	20"	48"	\$2,139
FCTTB-MOD.2054	20"	54"	\$2,188
FCTTB-MOD.2060	20"	60"	\$2,191
FCTTB-MOD.2072	20"	72"	\$2,283
FCTTB-MOD.2448	24"	48"	\$2,178
FCTTB-MOD.2454	24"	54"	\$2,225
FCTTB-MOD.2460	24"	60"	\$2,228
FCTTB-MOD.2472	24"	72"	\$2,320
FCTTB-MOD.3048	30"	48"	\$2,188
FCTTB-MOD.3054	30"	54"	\$2,243
FCTTB-MOD.3060	30"	60"	\$2,248
FCTTB-MOD.3072	30"	72"	\$2,340

CONNECTING BRACKET PAIR

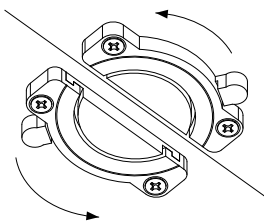

Model No.	Depth	Length	List
FCTTCB	-	-	\$45

DESK MOUNTED POWER UNIT



Model No.	Description	List	Notes
FPWR.DM	Clamp on Power Unit	\$454	<ul style="list-style-type: none"> The power cord comes attached to the unit. The cord measures approximately 6 ft in length Includes 3 plugs and 2 USB-A ports Distributes up to 10 amps Finish: available in BU and CW Clamp-on power unit may need to be moved or removed when nesting, contact Design (design@friant.com) to discuss specific application questions

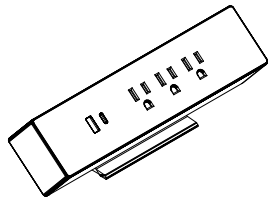

Model No.	Description	List	Notes
FPWR.DM-2	Adhesive Power Unit	\$454	<ul style="list-style-type: none"> The power cord comes attached to the unit. The cord measures approximately 6 ft in length Includes 3 plugs, 1 USB-C and 1 USB-A port Distributes up to 10 amps Finish: available in BU and CW

TABLE POWER DISTRIBUTION UNIT













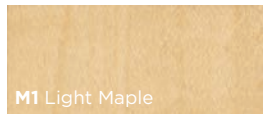
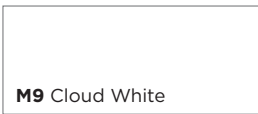
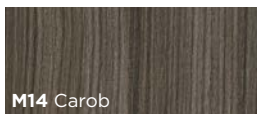
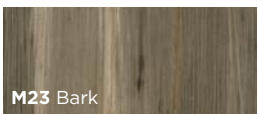
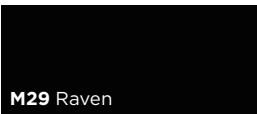
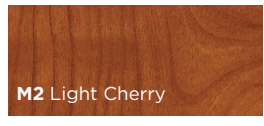

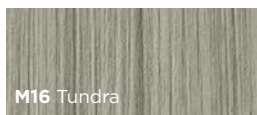
Model No.	Description	List	Notes
FD-SFC-306-4A	Table Power Distribution Unit	\$99	<ul style="list-style-type: none"> Power strip to attaches to the underside of tabletops For use with single circuit infeed (FD-BPI.1CIR)

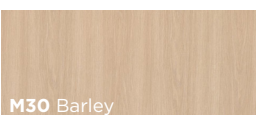
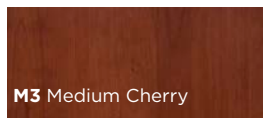
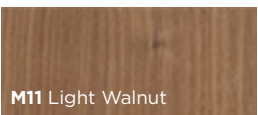
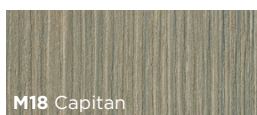
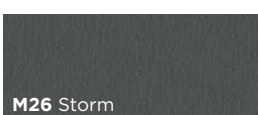

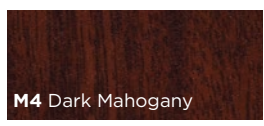



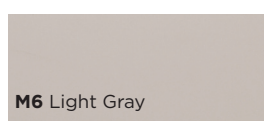

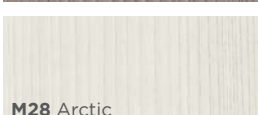



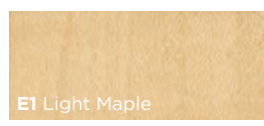
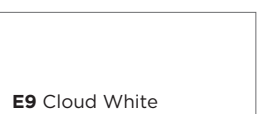
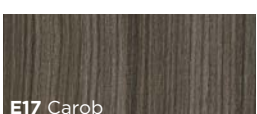
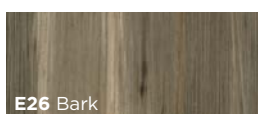

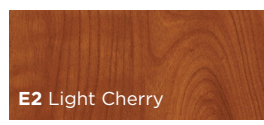
Model No.	Description	List	Notes
FD-BPI.1CIR	Single Circuit Infeed	\$113	<ul style="list-style-type: none"> Plug-in power infeed for use with table power distribution, 8' cord
FD-DCI.1CIR	Daisy Chain Power Connector	\$113	<ul style="list-style-type: none"> Connects adjacent table power units, 8' cord

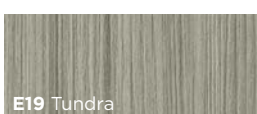
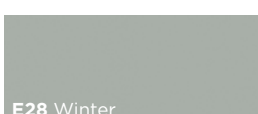
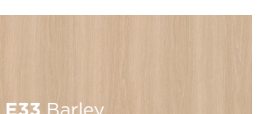
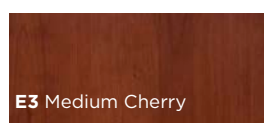
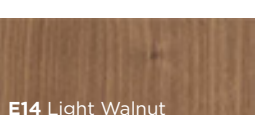
LUNE STANDARD FINISHES

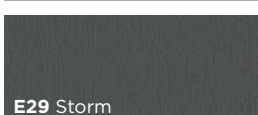
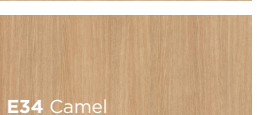
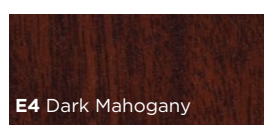
Top Finish

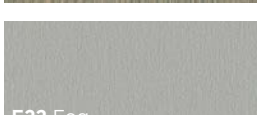
 M1 Light Maple	 M9 Cloud White	 M14 Carob	 M23 Bark	 M29 Raven
 M2 Light Cherry	 M10 Espresso	 M16 Tundra	 M25 Winter	 M30 Barley
 M3 Medium Cherry	 M11 Light Walnut	 M18 Capitan	 M26 Storm	 M31 Camel
 M4 Dark Mahogany	 M12 Medium Walnut	 M19 Fog	 M27 Medium Ash	
 M6 Light Gray	 M13 Licorice	 M20 Sandstone	 M28 Arctic	

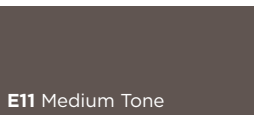
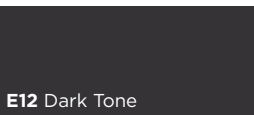
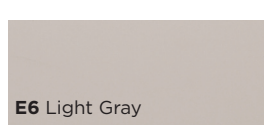
Edge Finish (PVC)

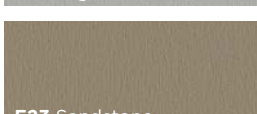
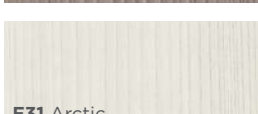
 E1 Light Maple	 E9 Cloud White	 E17 Carob	 E26 Bark	 E32 Raven
 E2 Light Cherry	 E10 Espresso	 E19 Tundra	 E28 Winter	 E33 Barley
 E3 Medium Cherry	 E14 Light Walnut	 E21 Capitan	 E29 Storm	 E34 Camel
 E4 Dark Mahogany	 E15 Medium Walnut	 E22 Fog	 E30 Medium Ash	<div data-bbox="1242 1596 1523 1898"> <p>Additional Edge Finishes</p>  E11 Medium Tone  E12 Dark Tone </div>
 E6 Light Gray	 E13 Licorice	 E23 Sandstone	 E31 Arctic	

LUNE STANDARD FINISHES

Finish

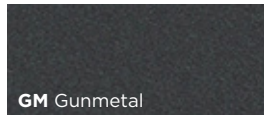

Modesty Finish

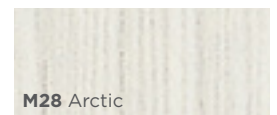
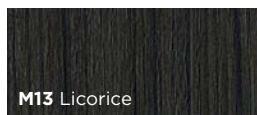
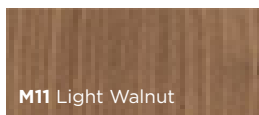
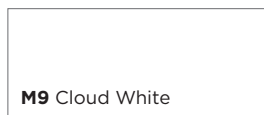

SCOPE

OCCASIONAL TABLES





FIND THE PERFECT FIT

With four heights and a wide range of shapes and sizes, these tables are ready to be where you need to be. Paired with Friant's range of stools and soft seating, it's easy to create a lounge area, meeting space, cafe space, and more.

OCCASIONAL
TABLES
SCOPE



Create spaces beyond the workstation that can foster connectivity or focus



SCOPE OCCASIONAL TABLE FEATURES

Ready to be where you want to be

SIZES AND SHAPES

Surface shapes and sizes to fit your needs, whether you're feeling square or thinking outside the box.

COLUMN HEIGHTS

Tubular steel column is offered in four different height options: lounge, table, counter, and bar

DISC BASE

Low profile weighted base for stability



THE COMPLETE PACKAGE

Friant offers stools and chairs in complementary heights to complete your space. See the options in our Seating Catalog at friant.com

SPECIFYING
OCCASIONAL
SCOPE

ORDERING IS EASY! 3 SIMPLE STEPS:

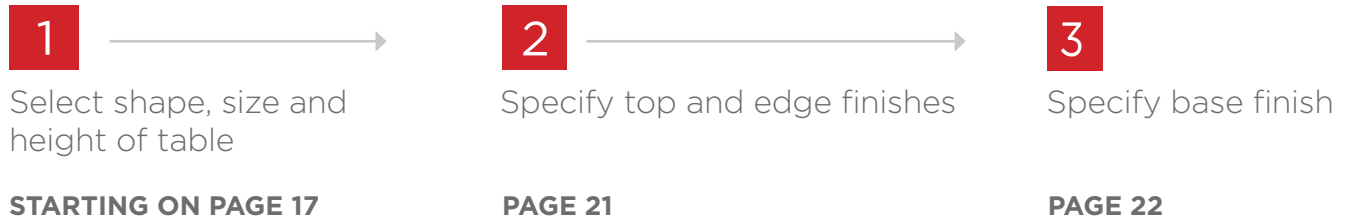

ANATOMY OF A PRODUCT NUMBER

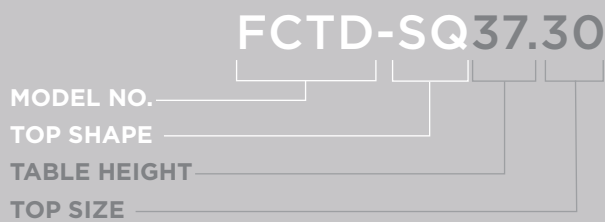

Be sure to specify finishes and base options in the description of your order.

Example:

FCTD-SQ37.30

Description:

Disc Base Table, 37”H, 30” Square Top

Top Finish:	M13	Licorice
Edge Finish:	E13	Licorice
Base Finish:	MB	Matte Black

LOUNGE HEIGHT, 19”H

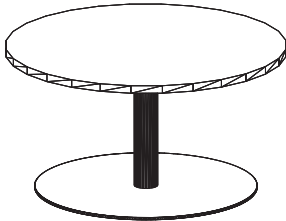

ROUND

Model No.	Top Size	List	
		Matte Black Base	Metal Base
FCTD-RD19.24	24"	\$1,254	\$1,444
FCTD-RD19.30	30"	\$1,643	\$1,833
FCTD-RD19.36	36"	\$1,983	\$2,173
FCTD-RD19.42	42"	\$1,989	\$2,179

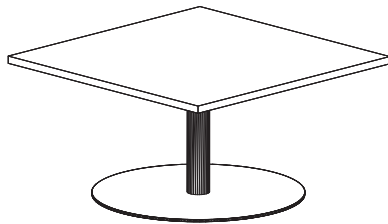

SQUARE

Model No.	Top Size	List	
		Matte Black Base	Metal Base
FCTD-SQ19.24	24"	\$1,208	\$1,398
FCTD-SQ19.30	30"	\$1,620	\$1,810
FCTD-SQ19.36	36"	\$1,940	\$2,130
FCTD-SQ19.42	42"	\$1,947	\$2,137

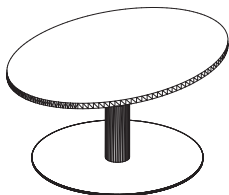

OVAL

SINGLE DISC BASE

Model No.	Top Size	List	
		Matte Black Base	Metal Base
FCTD-OV19.3042	30"x42"	\$1,760	\$1,950
FCTD-OV19.3048	30"x48"	\$1,764	\$1,954

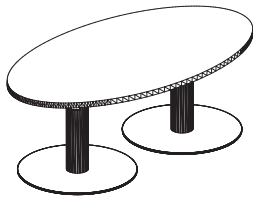

TWO DISC BASE

Model No.	Top Size	List	
		Matte Black Base	Metal Base
FCTD-OV19.3054	30"x54"	\$2,019	\$2,299
FCTD-OV19.3060	30"x60"	\$2,024	\$2,304

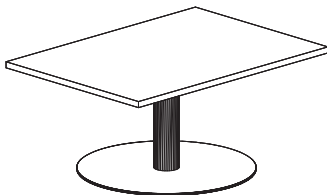

RECTANGULAR

SINGLE DISC BASE

Model No.	Top Size	List	
		Matte Black Base	Metal Base
FCTD-RT19.3042	30"x42"	\$1,676	\$1,866
FCTD-RT19.3048	30"x48"	\$1,681	\$1,871

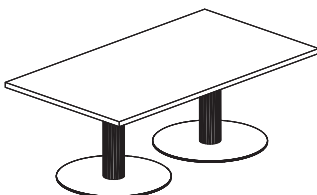

TWO DISC BASE

Model No.	Top Size	List	
		Matte Black Base	Metal Base
FCTD-RT19.3054	30"x54"	\$1,978	\$2,258
FCTD-RT19.3060	30"x60"	\$1,982	\$2,262

TABLE HEIGHT, 29"H

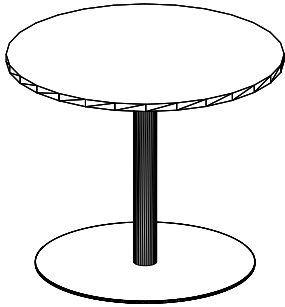

ROUND

Model No.	Top Size	List	
		Matte Black Base	Metal Base
FCTD-RD29.24	24"	\$1,265	\$1,455
FCTD-RD29.30	30"	\$1,653	\$1,843
FCTD-RD29.36	36"	\$1,994	\$2,184
FCTD-RD29.42	42"	\$2,035	\$2,225

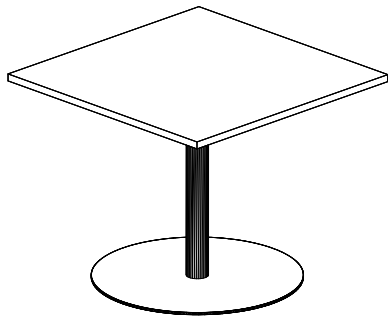

SQUARE

Model No.	Top Size	List	
		Matte Black Base	Metal Base
FCTD-SQ29.24	24"	\$1,219	\$1,409
FCTD-SQ29.30	30"	\$1,630	\$1,820
FCTD-SQ29.36	36"	\$1,951	\$2,141
FCTD-SQ29.42	42"	\$1,994	\$2,184

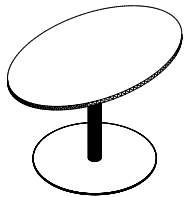

OVAL

SINGLE DISC BASE

Model No.	Top Size	List	
		Matte Black Base	Metal Base
FCTD-OV29.3048	30"x48"	\$1,783	\$1,973

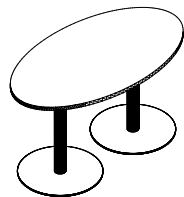

TWO DISC BASE

Model No.	Top Size	List	
		Matte Black Base	Metal Base
FCTD-OV29.3054	30"x54"	\$2,026	\$2,306
FCTD-OV29.3060	30"x60"	\$2,031	\$2,311

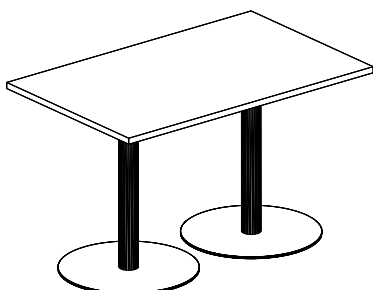

RECTANGULAR

TWO DISC BASE

Model No.	Top Size	List	
		Matte Black Base	Metal Base
FCTD-RT29.3048	30"x48"	\$1,876	\$2,156
FCTD-RT29.3054	30"x54"	\$1,984	\$2,264
FCTD-RT29.3060	30"x60"	\$1,990	\$2,270

COUNTER HEIGHT, 37”H

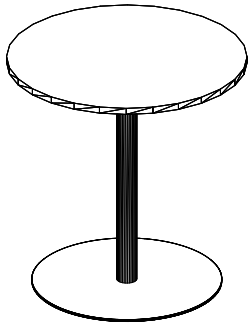

ROUND

Model No.	Top Size	List	
		Matte Black Base	Metal Base
FCTD-RD37.24	24"	\$1,295	\$1,485
FCTD-RD37.30	30"	\$1,683	\$1,873
FCTD-RD37.36	36"	\$2,025	\$2,215

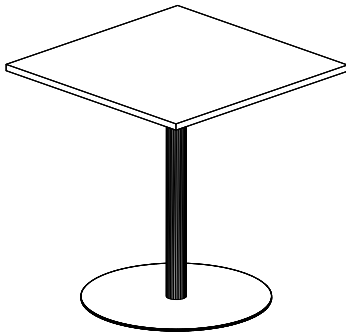

SQUARE

Model No.	Top Size	List	
		Matte Black Base	Metal Base
FCTD-SQ37.24	24"	\$1,249	\$1,439
FCTD-SQ37.30	30"	\$1,660	\$1,850
FCTD-SQ37.36	36"	\$1,982	\$2,172

BAR HEIGHT, 42”H

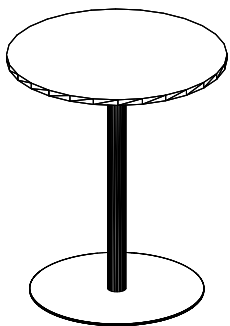

ROUND

Model No.	Top Size	List	
		Matte Black Base	Metal Base
FCTD-RD42.24	24"	\$1,304	\$1,494
FCTD-RD42.30	30"	\$1,692	\$1,882
FCTD-RD42.36	36"	\$2,032	\$2,222

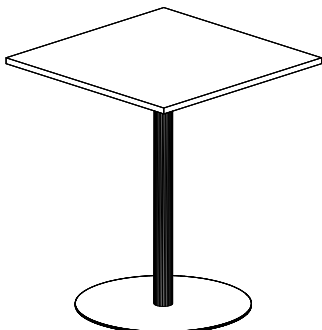

SQUARE

Model No.	Top Size	List	
		Matte Black Base	Metal Base
FCTD-SQ42.24	24"	\$1,258	\$1,448
FCTD-SQ42.30	30"	\$1,669	\$1,859
FCTD-SQ42.36	36"	\$1,990	\$2,180

TOP ONLY

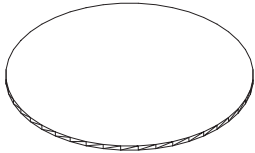

ROUND

Model No.	Top Size	List
FCD.24	24"	\$386
FCD.30	30"	\$464
FCD.36	36"	\$619
FCD.42	42"	\$731

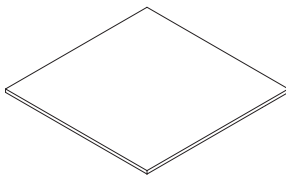

SQUARE

Model No.	Top Size	List
FCSQ.24	24"	\$299
FCSQ.30	30"	\$332
FCSQ.36	36"	\$441
FCSQ.42	42"	\$577

SCOPE STANDARD FINISHES

Top Finish

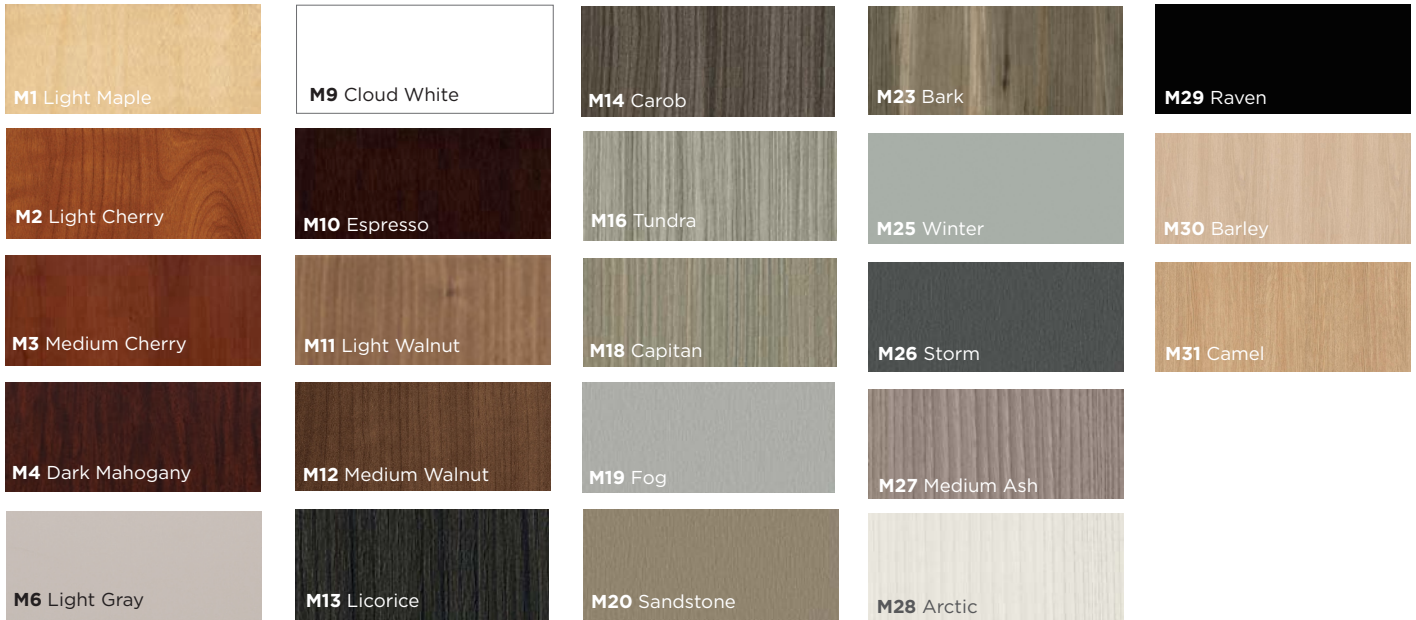

Edge Finish (PVC)

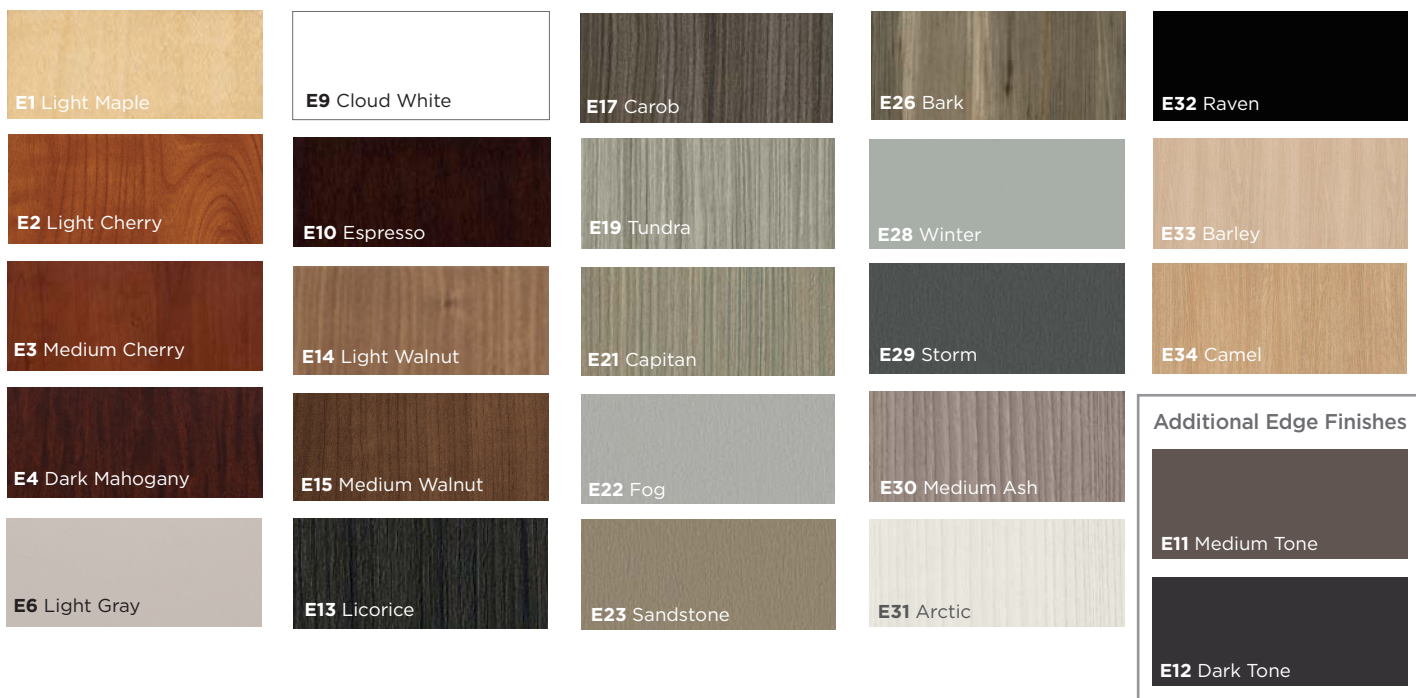

SCOPE STANDARD FINISHES

Base Finish

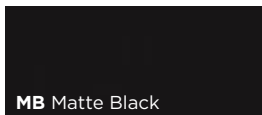

ROKE & RAFFE

TABLES



OCCASIONAL
TABLES
SCOPE



ROKE TABLES

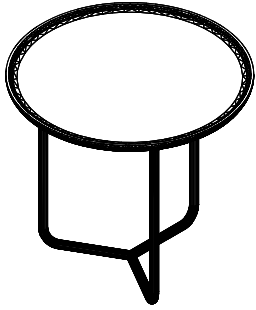

ROKE SIDE TABLE

Model No.	Top Size	Height	List
F452B	22"	20"	\$1,706

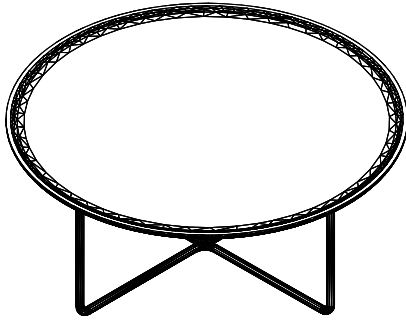

ROKE COFFEE TABLE

Model No.	Top Size	Height	List
F452E	40"	15"	\$3,110

RAFFE TABLES

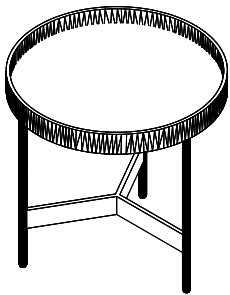

RAFFE SIDE TABLE

Model No.	Top Size	Height	List
F441B	20"	20"	\$1,706

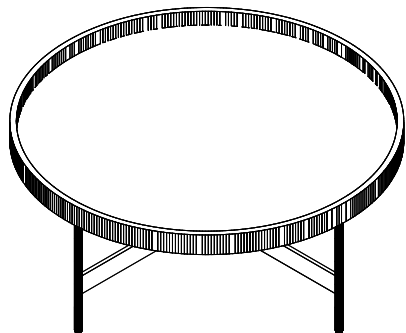

RAFFE COFFEE TABLE

Model No.	Top Size	Height	List
F441E	36"	15"	\$3,176

ROKE AND RAFFE STANDARD FINISHES

Roke Top Finish



Roke Base Finish

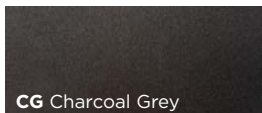

Raffe Top Finish

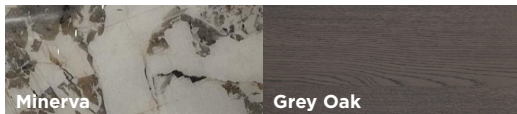

JG35-HB33 Minerva top with Grey Oak edge

Raffe Base Finish

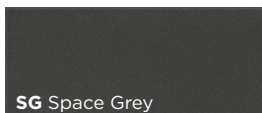

METAL BASE

TABLES



SPECIFYING
METAL BASE
TABLES

ORDERING IS EASY! 3 SIMPLE STEPS:

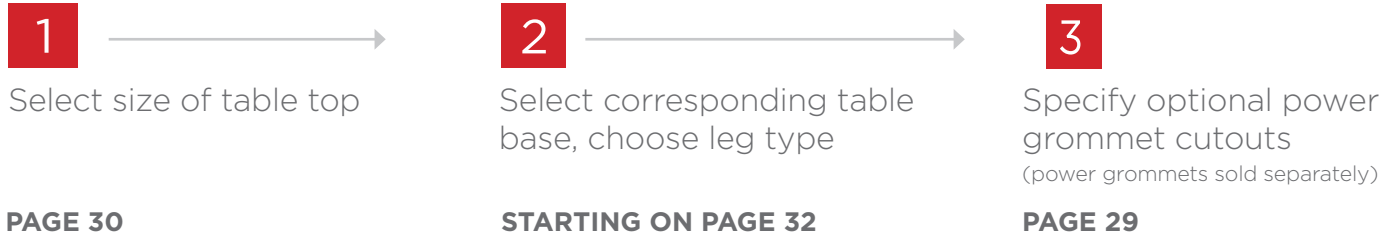

ANATOMY OF A PRODUCT NUMBER

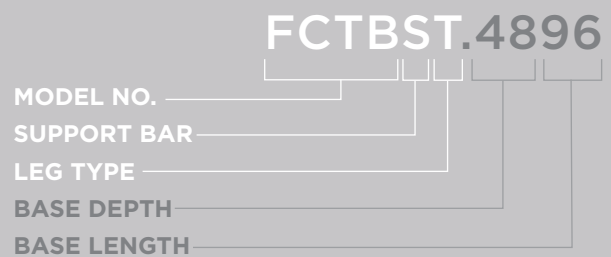
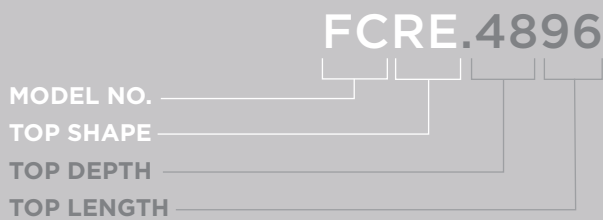

Be sure to specify finishes and base options in the description of your order.

Example:

FCRE.4896

Description:

Rectangular Conference Table Top, 48" x 96"

Top Finish: FB3920 Licorice Groovz

Edge Finish: E13 Licorice

Grommet Location: PG6C Grommet cutout

Example:

FCTBST.4896

Description:

Conference Table Base, Stright Taper, 48" x 96"

Finish: CW Cloud White

POWER GROMMET CUTOUT LOCATIONS

Factory cutouts for power grommets are available in 5x8 or 6x8 for use with Friant power grommets.

When selected, factory cutout option includes (1) cutout for tops up to 90"W, (2) cutouts for tops 96"W and up.

Order power grommets separately.

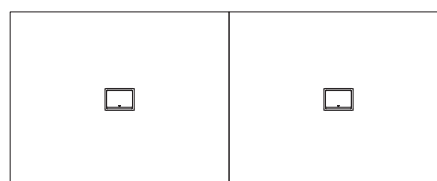
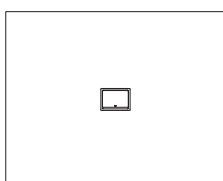

TABLE TOPS 48"W - 90"W

TABLE TOPS 96"W - 144"W

Code	Position	List Upcharge
PG5C	One cutout, for 5x8 power grommet. Centered on table top	\$75
PG6C	One cutout, for 6x8 power grommet. Centered on table top	\$75

Code	Position	List Upcharge
2-PG5C	Two cutouts for 5x8 power grommets, centered on each side	\$150
2-PG6C	Two cutouts for 6x8 power grommets, centered on each side"	\$150



RECTANGULAR TOP - 48"D

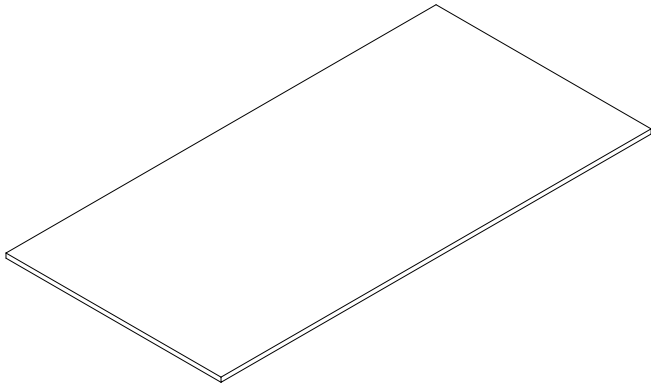

Model No.	Depth	Length	List
FCRE.4860	48"	60"	\$2,598
FCRE.4866	48"	66"	\$2,604
FCRE.4872	48"	72"	\$2,611
FCRE.4878	48"	78"	\$2,617
FCRE.4884	48"	84"	\$2,624
FCRE.4890	48"	90"	\$2,630
FCRE.4896	48"	96"	\$2,740
FCRE.48108	48"	108"	\$5,236
FCRE.48120	48"	120"	\$5,249
FCRE.48132	48"	132"	\$5,263
FCRE.48144	48"	144"	\$5,276
FCRE.48156	48"	156"	\$5,290

RECTANGULAR TOP - 60"D

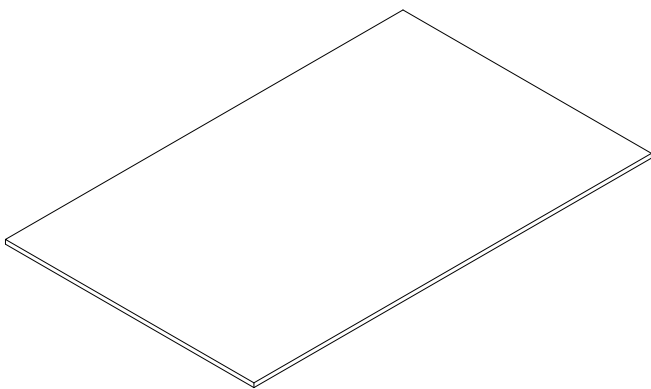

Model No.	Depth	Length	List
FCRE.6060	60"	60"	\$3,230
FCRE.6066	60"	66"	\$3,237
FCRE.6072	60"	72"	\$3,243
FCRE.6078	60"	78"	\$3,250
FCRE.6084	60"	84"	\$3,257
FCRE.6090	60"	90"	\$3,264
FCRE.6096	60"	96"	\$3,398
FCRE.60108	60"	108"	\$6,514
FCRE.60120	60"	120"	\$6,528
FCRE.60132	60"	132"	\$6,541
FCRE.60144	60"	144"	\$6,555
FCRE.60156	60"	156"	\$6,569

POWER GROMMET, 5X8

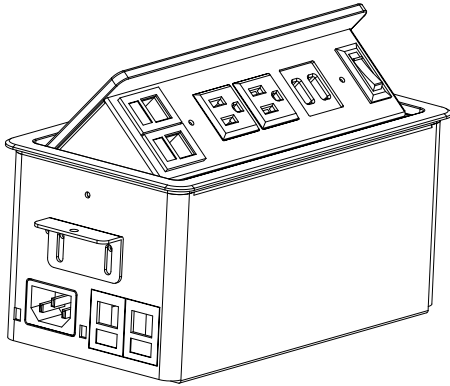

Model No.	Width	Depth	List
FPWR.0508	8"	5"	\$761

- WORKSURFACE MOUNTED POWER/DATA GROMMET, 5X8
- Includes 10' coiled power cord to connect to power source
 - Distributes up to 10 amps
 - **Above Worksurface:** (2) CAT6 data ports (out), (2) power outlets, (2) USB ports
 - **Below Worksurface:** (2) CAT6 data ports (in), (1) power outlet, Daisy Chain ports (in/out)
 - Finish Options: BA Brushed Aluminum, BC Brushed Charcoal or CW Cloud White (contact Customer Success for lead time)

POWER GROMMET, 6X8

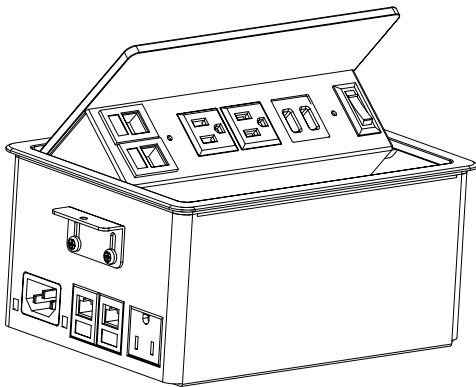

Model No.	Width	Depth	List
FPWR.0608	8"	6"	\$761

- WORKSURFACE MOUNTED POWER/DATA GROMMET, 6X8
- Includes 10' coiled power cord to connect to power source
 - Distributes up to 10 amps
 - **Above Worksurface:** (2) CAT6 data ports (out), (2) power outlets, (2) USB ports
 - **Below Worksurface:** (2) CAT6 data ports (in), (2) power outlets, Daisy Chain ports (in/out)
 - Finish Options: BA Brushed Aluminum, BC Brushed Charcoal or CW Cloud White (contact Customer Success for lead time)

STRAIGHT INSET BASE - 48"D

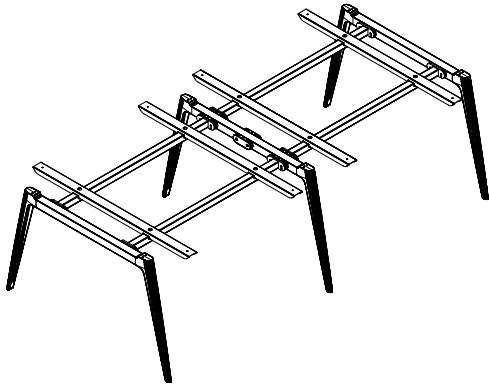

Model No.	Depth	Length	List
FCTBSI.4860	48"	60"	\$2,037
FCTBSI.4866	48"	66"	\$2,058
FCTBSI.4872	48"	72"	\$2,082
FCTBSI.4878	48"	78"	\$2,106
FCTBSI.4884	48"	84"	\$2,128
FCTBSI.4896	48"	96"	\$3,175
FCTBSI.48108	48"	108"	\$3,189
FCTBSI.48120	48"	120"	\$3,277
FCTBSI.48132	48"	132"	\$3,320
FCTBSI.48144	48"	144"	\$3,369

STRAIGHT INSET BASE - 60"D

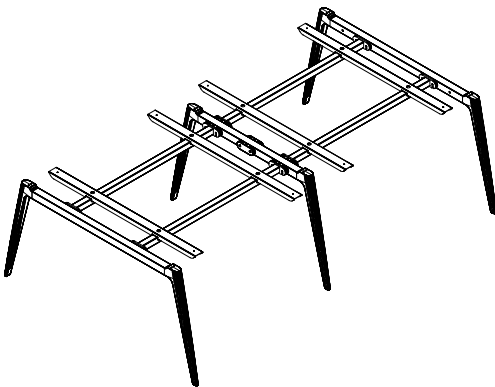

Model No.	Depth	Length	List
FCTBSI.6060	60"	60"	\$2,068
FCTBSI.6066	60"	66"	\$2,089
FCTBSI.6072	60"	72"	\$2,113
FCTBSI.6078	60"	78"	\$2,137
FCTBSI.6084	60"	84"	\$2,159
FCTBSI.6096	60"	96"	\$3,207
FCTBSI.60108	60"	108"	\$3,220
FCTBSI.60120	60"	120"	\$3,308
FCTBSI.60132	60"	132"	\$3,351
FCTBSI.60144	60"	144"	\$3,400

CONCAVE INSET BASE - 48"D

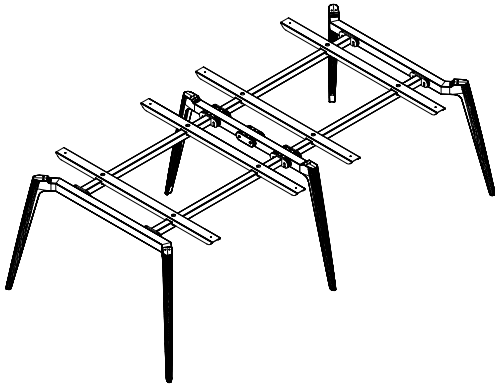

Model No.	Depth	Length	List
FCTBCI.4860	48"	60"	\$1,967
FCTBCI.4866	48"	66"	\$1,973
FCTBCI.4872	48"	72"	\$2,018
FCTBCI.4878	48"	78"	\$2,038
FCTBCI.4884	48"	84"	\$2,063
FCTBCI.4896	48"	96"	\$3,147
FCTBCI.48108	48"	108"	\$3,155
FCTBCI.48120	48"	120"	\$3,169
FCTBCI.48132	48"	132"	\$3,258
FCTBCI.48144	48"	144"	\$3,301

CONCAVE INSET BASE - 60"D

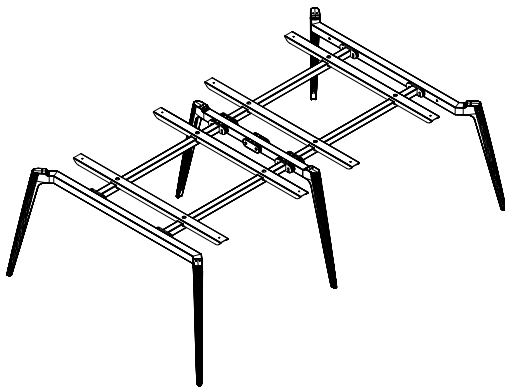

Model No.	Depth	Length	List
FCTBCI.6060	60"	60"	\$2,013
FCTBCI.6066	60"	66"	\$2,019
FCTBCI.6072	60"	72"	\$2,064
FCTBCI.6078	60"	78"	\$2,085
FCTBCI.6084	60"	84"	\$2,110
FCTBCI.6096	60"	96"	\$3,194
FCTBCI.60108	60"	108"	\$3,203
FCTBCI.60120	60"	120"	\$3,215
FCTBCI.60132	60"	132"	\$3,305
FCTBCI.60144	60"	144"	\$3,348

STRAIGHT TAPER BASE - 48"D

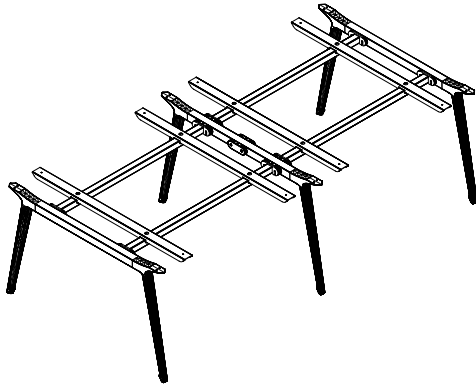

Model No.	Depth	Length	List
FCTBST.4860	48"	60"	\$2,221
FCTBST.4866	48"	66"	\$2,242
FCTBST.4872	48"	72"	\$2,266
FCTBST.4878	48"	78"	\$2,290
FCTBST.4884	48"	84"	\$2,312
FCTBST.4896	48"	96"	\$3,451
FCTBST.48108	48"	108"	\$3,465
FCTBST.48120	48"	120"	\$3,553
FCTBST.48132	48"	132"	\$3,596
FCTBST.48144	48"	144"	\$3,645

STRAIGHT TAPER BASE - 60"D

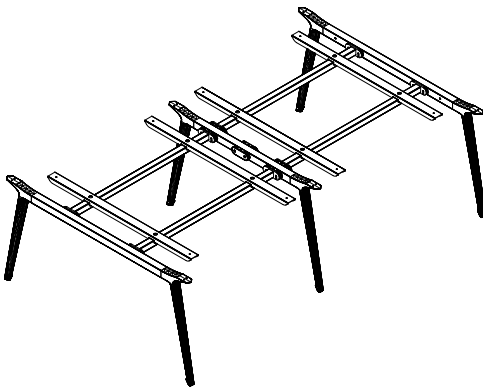

Model No.	Depth	Length	List
FCTBST.6060	60"	60"	\$2,252
FCTBST.6066	60"	66"	\$2,273
FCTBST.6072	60"	72"	\$2,297
FCTBST.6078	60"	78"	\$2,321
FCTBST.6084	60"	84"	\$2,343
FCTBST.6096	60"	96"	\$3,482
FCTBST.60108	60"	108"	\$3,496
FCTBST.60120	60"	120"	\$3,585
FCTBST.60132	60"	132"	\$3,627
FCTBST.60144	60"	144"	\$3,673

CONCAVE TAPER BASE - 48"D

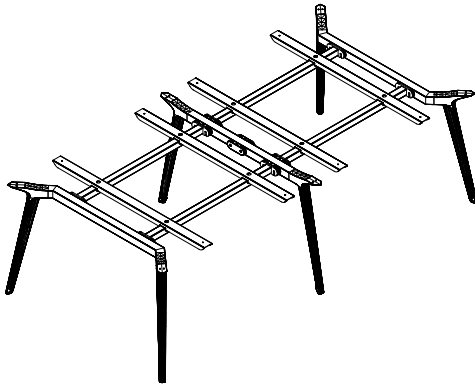

Model No.	Depth	Length	List
FCTBCT.4860	48"	60"	\$2,150
FCTBCT.4866	48"	66"	\$2,157
FCTBCT.4872	48"	72"	\$2,201
FCTBCT.4878	48"	78"	\$2,222
FCTBCT.4884	48"	84"	\$2,247
FCTBCT.4896	48"	96"	\$3,423
FCTBCT.48108	48"	108"	\$3,431
FCTBCT.48120	48"	120"	\$3,445
FCTBCT.48132	48"	132"	\$3,534
FCTBCT.48144	48"	144"	\$3,577



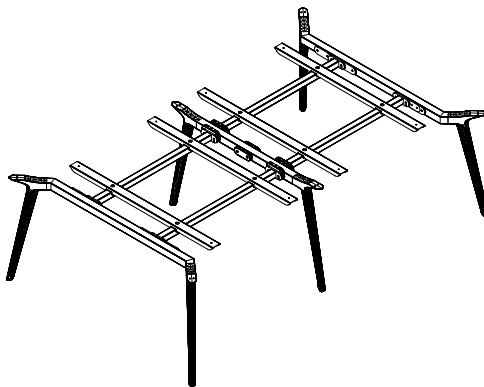







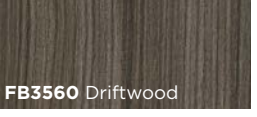
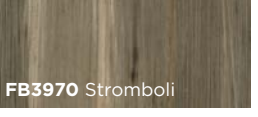
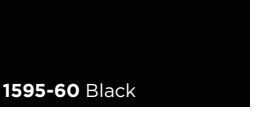
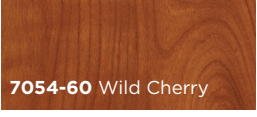
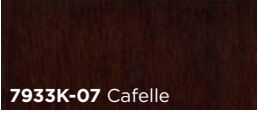

CONCAVE TAPER BASE - 60"D



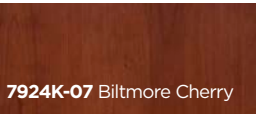
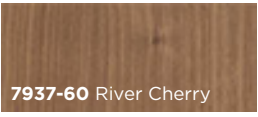
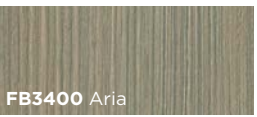

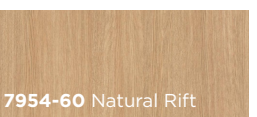
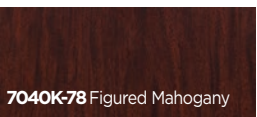



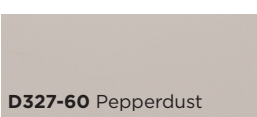
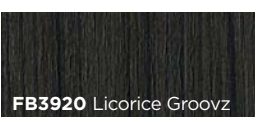
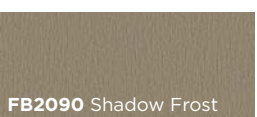
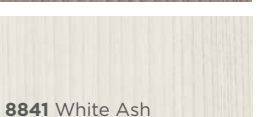



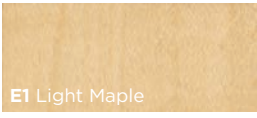

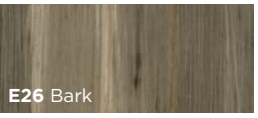
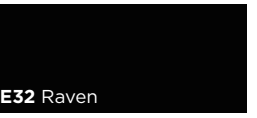
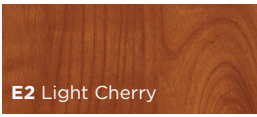

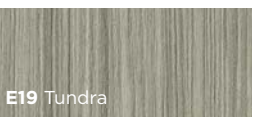

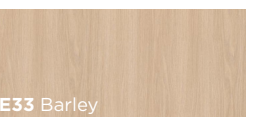
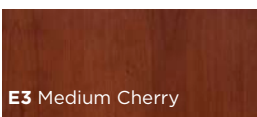
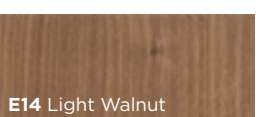
Model No.	Depth	Length	List
FCTBCT.6060	60"	60"	\$2,197
FCTBCT.6066	60"	66"	\$2,203
FCTBCT.6072	60"	72"	\$2,248
FCTBCT.6078	60"	78"	\$2,269
FCTBCT.6084	60"	84"	\$2,294
FCTBCT.6096	60"	96"	\$3,470
FCTBCT.60108	60"	108"	\$3,479
FCTBCT.60120	60"	120"	\$3,491
FCTBCT.60132	60"	132"	\$3,581
FCTBCT.60144	60"	144"	\$3,624

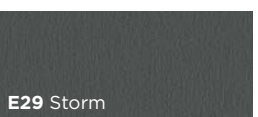
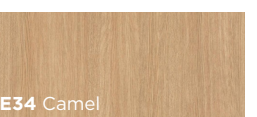
METAL BASE TABLE STANDARD FINISHES - TOPS

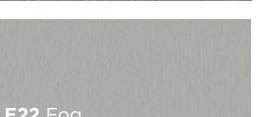
Top Finish

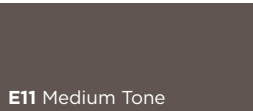
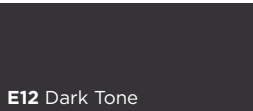
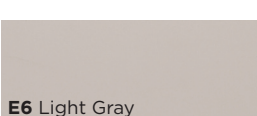
 7909-60 Fusion Maple	 1573-60 Frosty White	 FB3560 Driftwood	 FB3970 Stromboli	 1595-60 Black
 7054-60 Wild Cherry	 7933K-07 Cafelle	 FB3930 Concrete Groovz	 FB2130 Fog Grey	 7850-60 Beigewood
 7924K-07 Biltmore Cherry	 7937-60 River Cherry	 FB3400 Aria	 FB2000 Pewter Frost	 7954-60 Natural Rift
 7040K-78 Figured Mahogany	 7965K-12 Walnut Heights	 FB2100 Silver Frost	 8842 Weathered Ash	
 D327-60 Pepperdust	 FB3920 Licorice Groovz	 FB2090 Shadow Frost	 8841 White Ash	

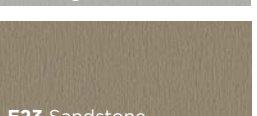
Edge Finish (PVC)

 E1 Light Maple	 E9 Cloud White	 E17 Carob	 E26 Bark	 E32 Raven
 E2 Light Cherry	 E10 Espresso	 E19 Tundra	 E28 Winter	 E33 Barley
 E3 Medium Cherry	 E14 Light Walnut	 E21 Capitan	 E29 Storm	 E34 Camel
 E4 Dark Mahogany	 E15 Medium Walnut	 E22 Fog	 E30 Medium Ash	<div data-bbox="1240 1598 1523 1898"> <p>Additional Edge Finishes</p>  E11 Medium Tone  E12 Dark Tone </div>
 E6 Light Gray	 E13 Licorice	 E23 Sandstone	 E31 Arctic	

METAL BASE TABLE STANDARD FINISHES - BASES

Finish

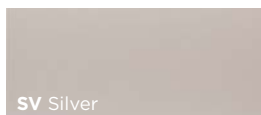
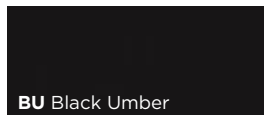

MESA

CONFERENCE TABLES





THE ULTIMATE IN PLUG & PLAY CONFERENCING

Meeting set up has never been simpler. Friant's innovative inset trough holds voice, data, and electrical outlets that keep cables organized and out of sight for an uncluttered surface conducive to focus and planning. The trough has a brushed opening and the capacity for enough voice/data and electrical wiring to power up each seat at the table. Additional cable storage space in bases.



Beneath Mesa's beauty is an ingenious design — power trough and bases that store and organize cables for a complete plug and play experience



Trough Intelligence

Friant's innovative trough organizes voice, data, and electrical cables with separate raceways for power and data.

Custom without cost

With three table shapes, a dozen edge finishes and multiple base finish options, each Mesa table can be designed with a unique aesthetic. Mesa marries beauty and functionality while remaining at a competitive price point.



Cables have two entry points to the power and data ports — through the top doors and the base columns with detachable covers. Open channel in the base also holds cables and wires.

Mesa makes connectivity easy with IT access integral to its design.

VOICE & DATA

Separate channels for voice and data keeps the cable area organized

Voice/data jacks and wiring not included.

POWER

Power capacity matches table seating, so each person at the table has a power and data outlet.

example:

An 8 ft. table has 8 outlets, a 12 ft. table has 12 outlets, etc.

Power strips are single circuit soft wire style plug-in.

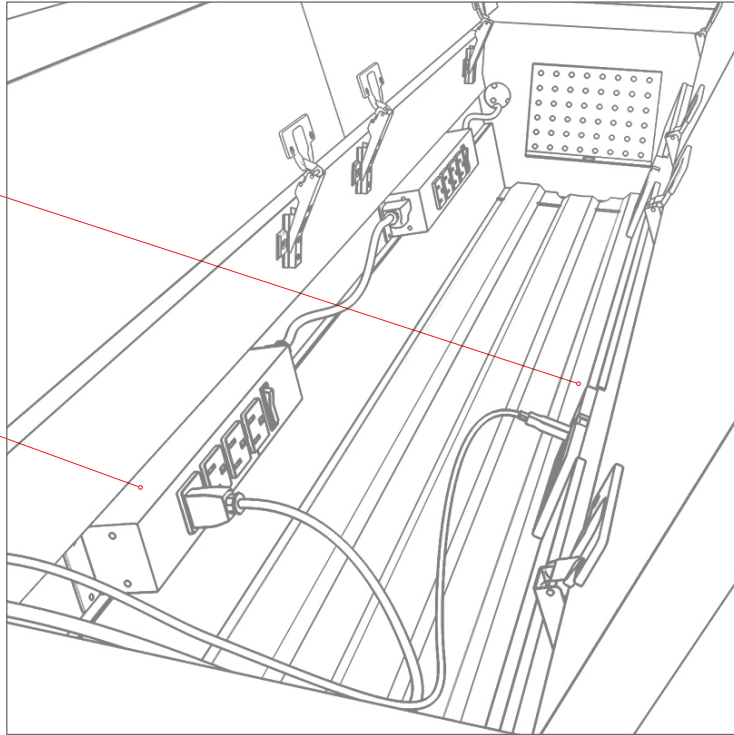

For dimensions, see page 55





Mesa is as environmentally sound as it is innovative, with materials that offer air quality assurance and LEED point contributions for recycled content

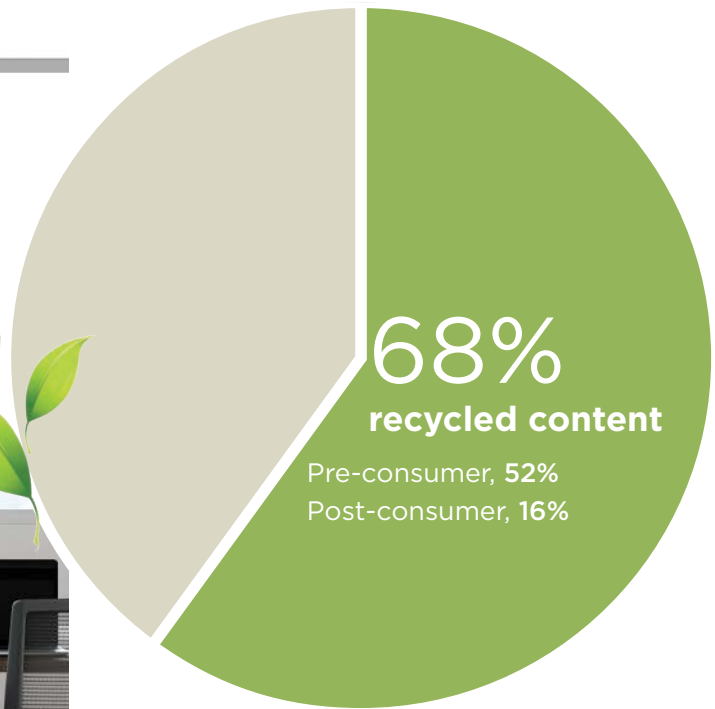

*LEED point contributions will vary according to table specifications; this chart references the table shown on page 43

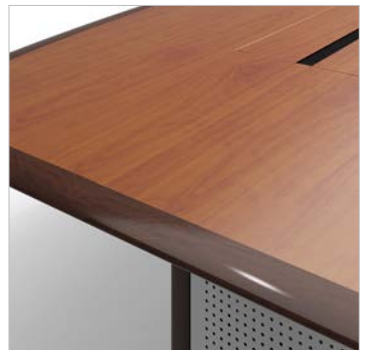
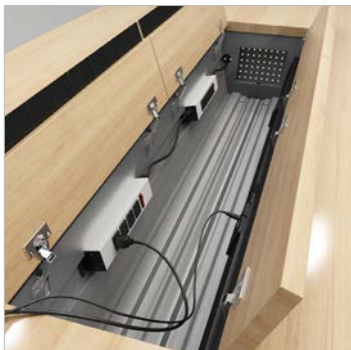

ORDERING MESA IS EASY! 4 SIMPLE STEPS:

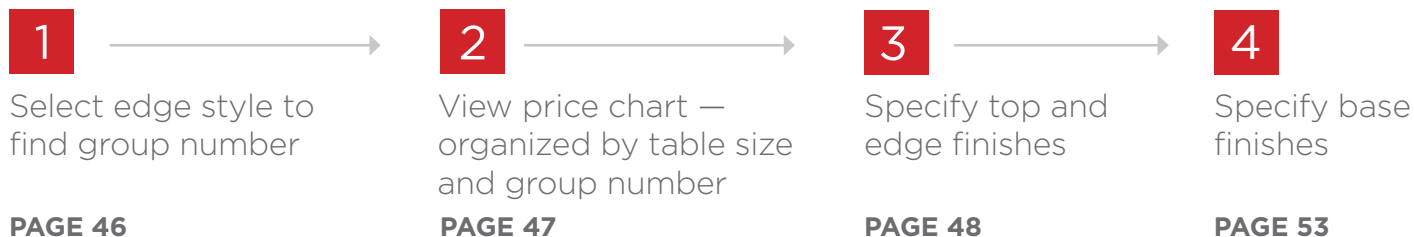

ANATOMY OF A PRODUCT NUMBER

MTB-BT-3648240-10-K

MODEL NO.

EDGE GROUP

EDGE STYLE

Model numbers are found in the pricing table on page 47. Add the edge group and style to create the complete product number for your Mesa table.

Be sure to specify finishes and base options in the description of your order.

Example:

MTB-BT-3648240-10-K

Description:

Mesa Table, Boatshaped, 36 x 48 x 240, Style Group 10, Edge Style K

Top Finish: VN01 American Cherry

Edge Finish: VD01 American Cherry

Base Inset Finish: VB01 American Cherry

Base Column Finish: VC01 American Cherry

American Cherry top and edge, with American Cherry base insert and columns

1 SELECT STYLE GROUP

Your choice of top and edge material determines your edge style options.



Laminate (self) edge PVC edge

Group 1

Laminate top with laminate or PVC edge



Group 9

Laminate top with solid wood edge



Group 10

Veneer top with solid wood edge

Available Edge Styles: A & B



A 3 mm PVC B Self Edge

Available Edge Styles: J, K, J, M, N, P, Q



J Radius



K Bevel



L Beaded



M Knife



N Reverse Knife



P Double Radius



Q Bullnose

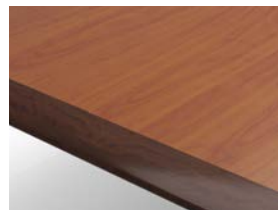

Group 12

Laminate top with solid wood edge



Group 13

Veneer top with solid wood edge

Available Edge Styles: S, T, W



S Ellipse 2.5"



T Ellipse 3.5"



W Ellipse 4.5"

2 FIND STYLE GROUP PRICING

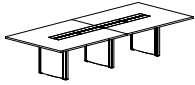

Rectangle Table

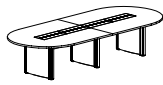

Racetrack Table

Size	Model No.	Model No.	Group 1	Group 9	Group 10	Group 12	Group 13
4' x 8'	MTB-RE-4896	MTB-RT-4896	\$11,720	\$18,166	\$19,922	\$23,441	\$25,785
4' x 9'	MTB-RE-48108	MTB-RT-48108	\$12,840	\$19,903	\$21,828	\$25,681	\$28,250
4' x 10'	MTB-RE-48120	MTB-RT-48120	\$15,302	\$23,719	\$26,013	\$30,605	\$33,665
4' x 11'	MTB-RE-48132	MTB-RT-48132	\$17,896	\$27,737	\$30,420	\$35,789	\$39,370
4' x 12'	MTB-RE-48144	MTB-RT-48144	\$18,591	\$28,815	\$31,603	\$37,181	\$40,898
4' x 14'	MTB-RE-48168	MTB-RT-48168	\$21,386	\$33,152	\$36,359	\$42,776	\$47,053
4' x 16'	MTB-RE-48192	MTB-RT-48192	\$22,470	\$34,829	\$38,199	\$44,940	\$49,435
4' x 18'	MTB-RE-48216	MTB-RT-48216	\$27,063	\$41,949	\$46,009	\$54,128	\$59,542
4' x 20'	MTB-RE-48240	MTB-RT-48240	\$28,319	\$43,894	\$48,145	\$56,639	\$62,303
4' x 22'	MTB-RE-48264	MTB-RT-48264	\$30,750	\$47,633	\$52,276	\$61,501	\$67,652
5' x 10'	MTB-RE-60120	MTB-RT-60120	\$18,257	\$28,297	\$31,034	\$36,511	\$40,162
5' x 12'	MTB-RE-60144	MTB-RT-60144	\$21,477	\$33,289	\$36,511	\$42,955	\$47,250
5' x 14'	MTB-RE-60168	MTB-RT-60168	\$23,720	\$36,766	\$36,772	\$47,440	\$52,186
5' x 16'	MTB-RE-60192	MTB-RT-60192	\$25,912	\$40,165	\$44,052	\$51,826	\$57,007
5' x 18'	MTB-RE-60216	MTB-RT-60216	\$30,916	\$47,919	\$52,559	\$61,831	\$68,013
5' x 20'	MTB-RE-60240	MTB-RT-60240	\$33,281	\$51,585	\$56,576	\$61,232	\$73,217
5' x 22'	MTB-RE-60264	MTB-RT-60264	\$35,157	\$54,493	\$59,767	\$70,317	\$77,346

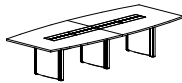

Boatshape Table

Size	Model No.	Group 1	Group 9	Group 10	Group 12	Group 13
3' x 4' x 8'	MTB-BT-364896	\$11,720	\$18,166	\$19,922	\$23,441	\$25,785
3' x 4' x 9'	MTB-BT-3648108	\$12,840	\$19,903	\$21,828	\$25,681	\$28,250
3' x 4' x 10'	MTB-BT-3648120	\$15,302	\$23,719	\$26,013	\$30,605	\$33,665
3' x 4' x 11'	MTB-BT-3648132	\$17,896	\$27,737	\$30,420	\$35,789	\$39,370
3' x 4' x 12'	MTB-BT-3648144	\$18,591	\$28,815	\$31,603	\$37,181	\$40,898
3' x 4' x 14'	MTB-BT-3648168	\$21,386	\$33,152	\$36,359	\$42,776	\$47,053
3' x 4' x 16'	MTB-BT-3648192	\$22,470	\$34,829	\$38,199	\$44,940	\$49,435
3' x 4' x 18'	MTB-BT-3648216	\$27,063	\$41,949	\$46,009	\$54,128	\$59,542
3' x 4' x 20'	MTB-BT-3648240	\$28,319	\$43,894	\$48,145	\$56,639	\$62,303
3' x 4' x 22'	MTB-BT-3648264	\$30,750	\$47,664	\$52,276	\$61,501	\$67,652
4' x 5' x 10'	MTB-BT-4860120	\$18,257	\$28,297	\$31,034	\$36,511	\$40,162
4' x 5' x 12'	MTB-BT-4860144	\$21,477	\$33,289	\$36,511	\$42,955	\$47,250
4' x 5' x 14'	MTB-BT-4860168	\$23,720	\$36,766	\$40,324	\$47,440	\$52,186
4' x 5' x 16'	MTB-BT-4860192	\$25,912	\$40,165	\$44,052	\$51,826	\$57,007
4' x 5' x 18'	MTB-BT-4860216	\$30,916	\$47,919	\$52,559	\$61,831	\$68,013
4' x 5' x 20'	MTB-BT-4860240	\$33,281	\$51,585	\$56,576	\$66,560	\$73,217
4' x 5' x 22'	MTB-BT-4860264	\$35,157	\$54,493	\$59,767	\$70,317	\$77,346

3 SELECT FINISHES: TOP

Table top finish choices includes laminate or veneer. See chart below

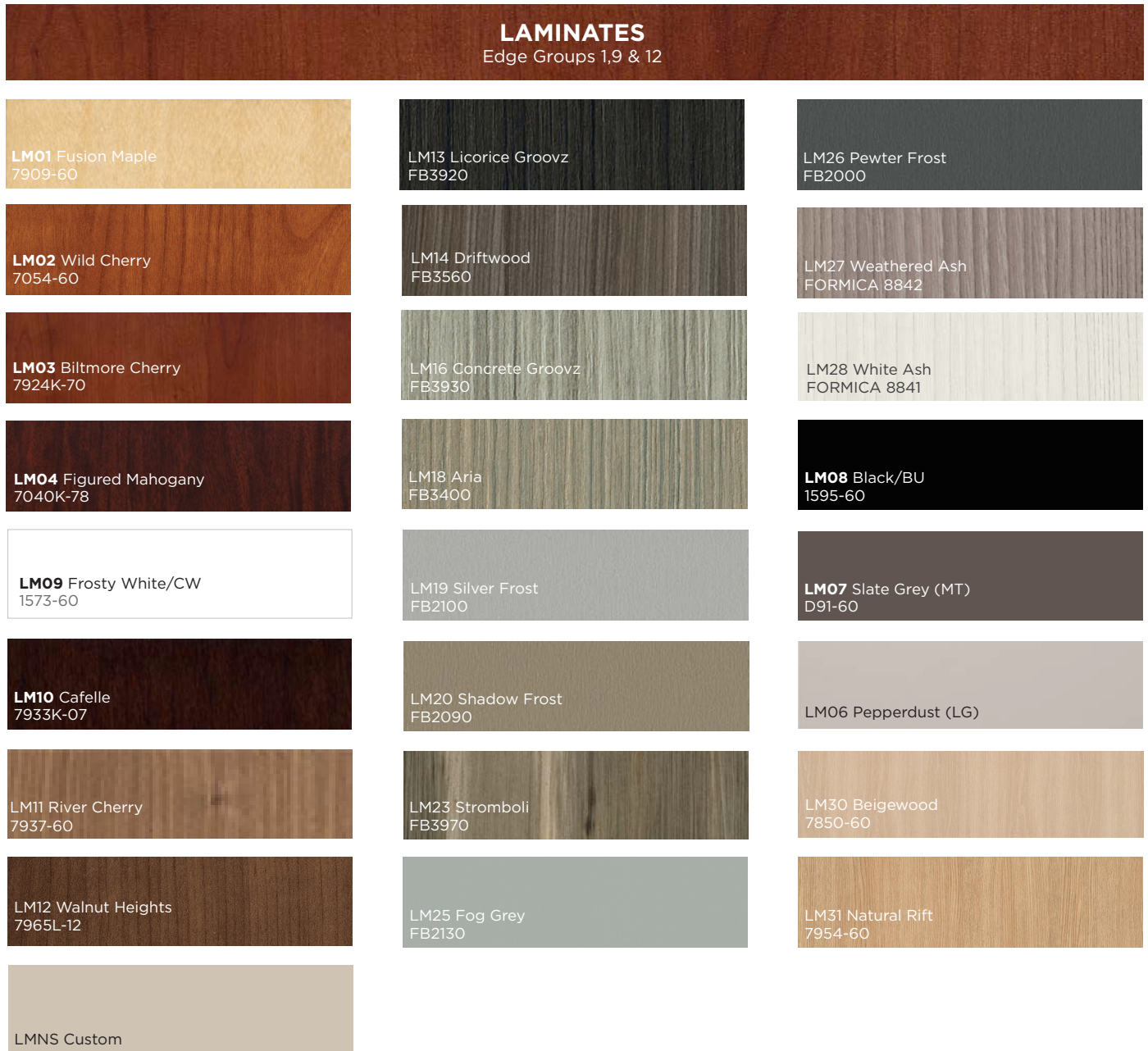

CARB COMPLIANT

Willow laminates meet or exceed California (CARB) air quality emission standards — the most stringent in the country — for composite wood products.

Contact suppliers directly for hardsurface panel **finish samples**.

Wilsonart

tel: 800-433-3222, <https://www.wilsonart.com/contact-us>

Formica

tel: 800-367-6422, <https://www.formica.com/en-us/collections/commercial-ranges>

Arauco

Samples can be ordered at <https://store.samplingproduct.com/8340>

3 SELECT FINISHES: VENEER

Table top finish choices: Veneer

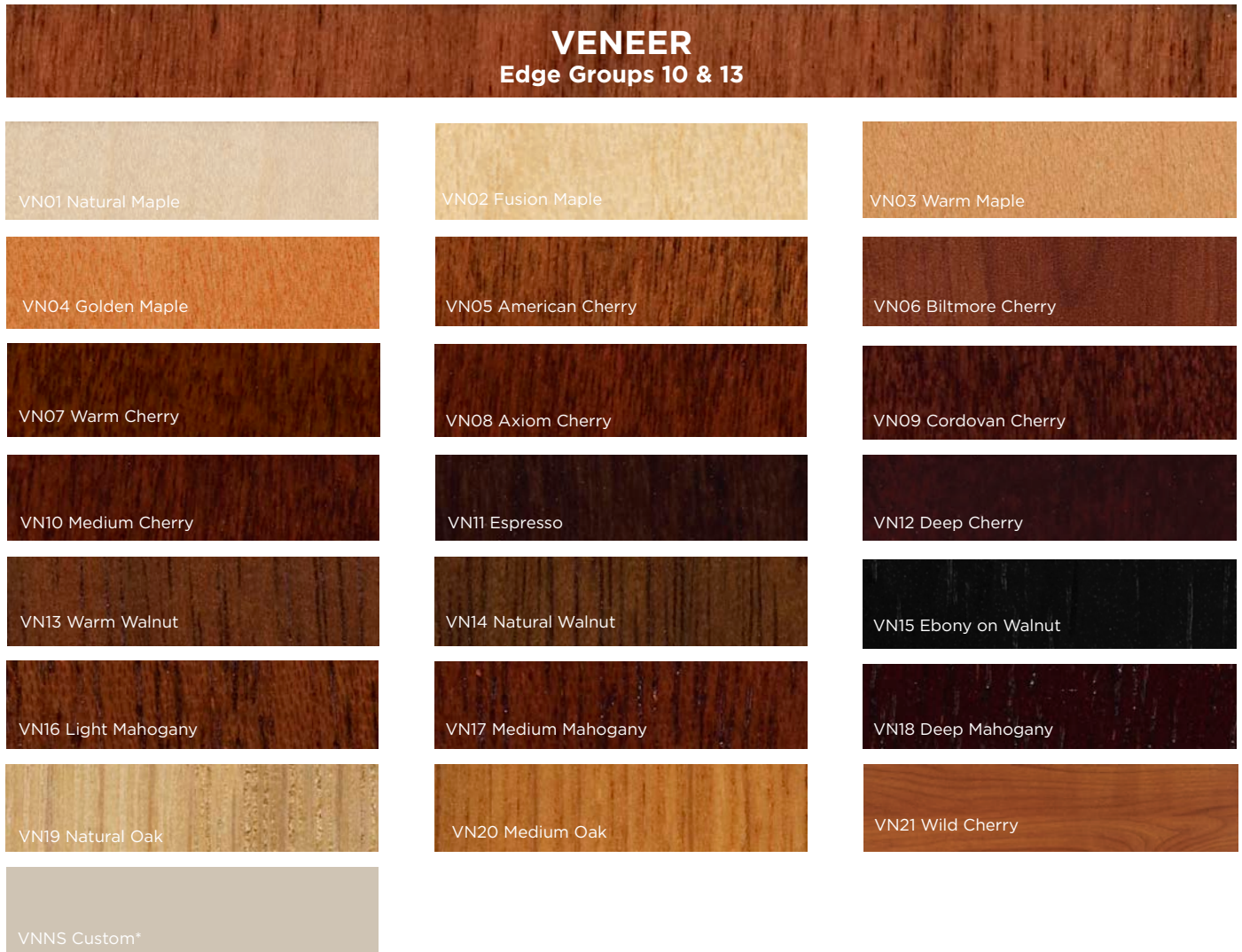

* For pricing on custom finishes, contact your Friant Sales Consultant.

3 SELECT FINISHES: EDGE



Table edge finish choices: solid wood

SOLID WOOD EDGE

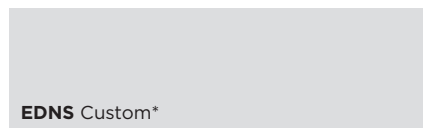
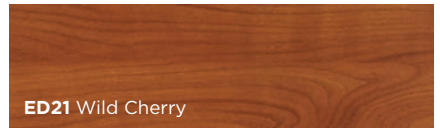
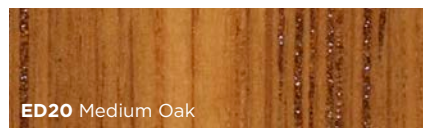
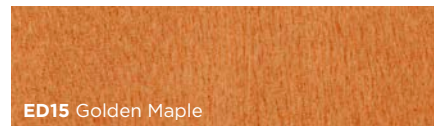
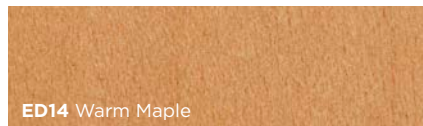
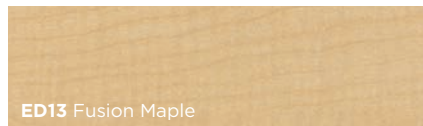
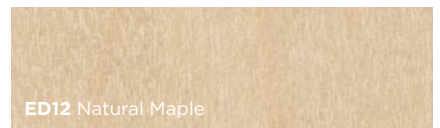
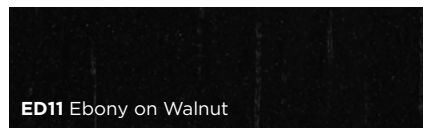
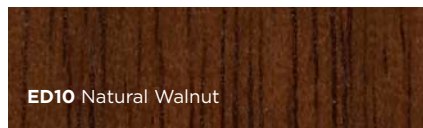
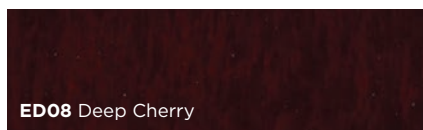
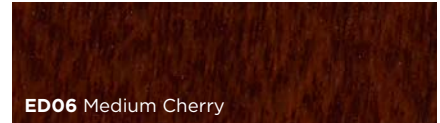
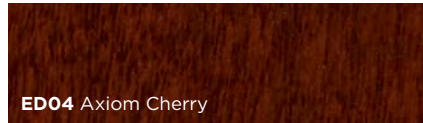
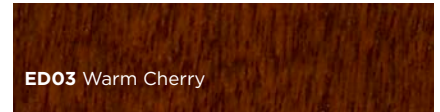
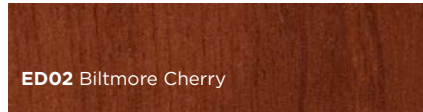
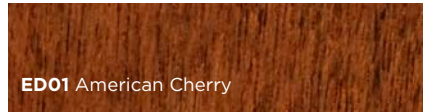









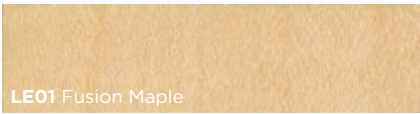
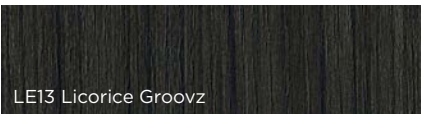
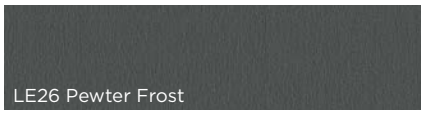
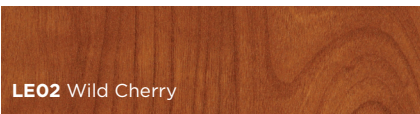

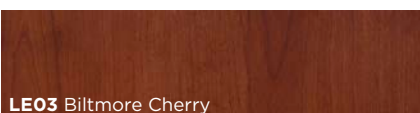
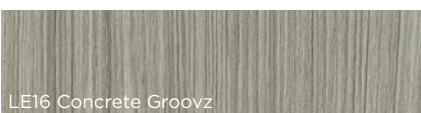



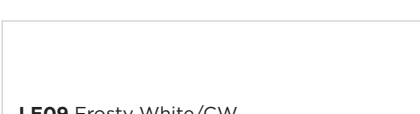

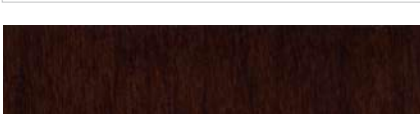
3 SELECT FINISHES: EDGE



Table edge finish choices: Laminate and PVC.

LAMINATE EDGE

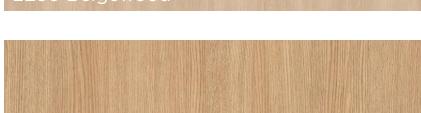
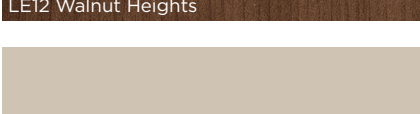
 <p>LE01 Fusion Maple</p>	 <p>LE13 Licorice Groovz</p>	 <p>LE26 Pewter Frost</p>
 <p>LE02 Wild Cherry</p>	 <p>LE14 Driftwood</p>	 <p>LE27 Weathered Ash</p>
 <p>LE03 Biltmore Cherry</p>	 <p>LE16 Concrete Groovz</p>	 <p>LE28 White Ash</p>
 <p>LE04 Figured Mahogany</p>	 <p>LE18 Aria</p>	 <p>LE08 Black/BU</p>
 <p>LE09 Frosty White/CW</p>	 <p>LE19 Silver Frost</p>	 <p>LE05 Slate Grey (MT)</p>
 <p>LE10 Cafelle</p>	 <p>LE20 Shadow Frost</p>	 <p>LE06 Pepperdust (LG)</p>
 <p>LE11 River Cherry</p>	 <p>LE23 Stromboli</p>	 <p>LE30 Beigewood</p>
 <p>LE12 Walnut Heights</p>	 <p>LE25 Fog Grey</p>	 <p>LE31 Natural Rift</p>
 <p>LMNS Custom</p>		



PVC EDGE



PV01 Fusion Maple

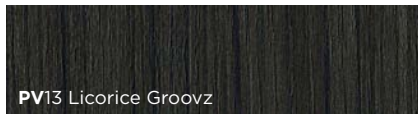

PV13 Licorice Groovz

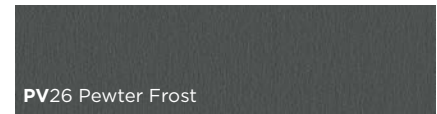

PV26 Pewter Frost

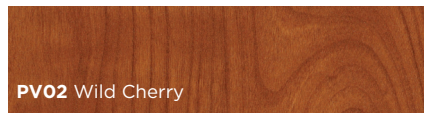

PV02 Wild Cherry



PV14 Driftwood

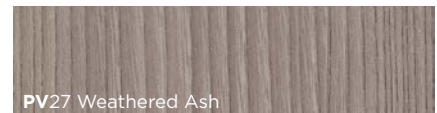

PV27 Weathered Ash

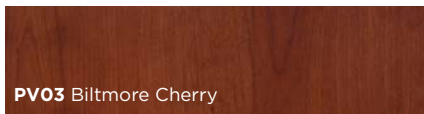

PV03 Biltmore Cherry

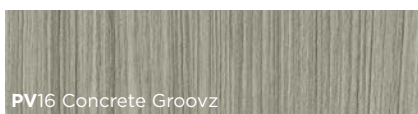

PV16 Concrete Groovz

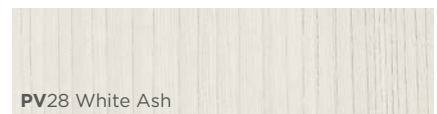

PV28 White Ash

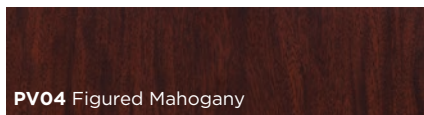

PV04 Figured Mahogany

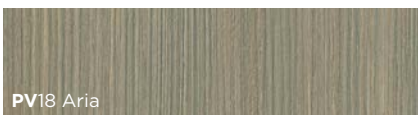

PV18 Aria



PV08 Black/BU



PV09 Frosty White/CW

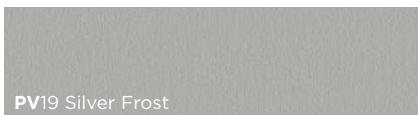

PV19 Silver Frost

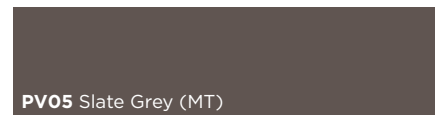

PV05 Slate Grey (MT)



PV10 Cafelle



PV20 Shadow Frost

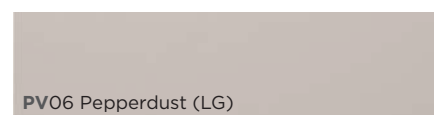

PV06 Pepperdust (LG)

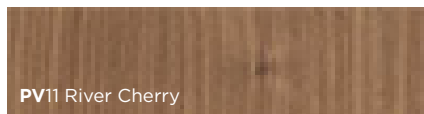

PV11 River Cherry



PV23 Stromboli



PV30 Beigewood



PV12 Walnut Heights



PV25 Fog Grey

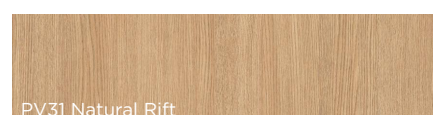

PV31 Natural Rift



LMNS Custom



Order samples at www.friant.com

Please Note: Images are printed simulations and are not exact matches of finished product. Please request an actual sample from Friant or your sales consultant before specifying finishes.

4 SELECT BASE OPTION

Select an inset finish and column finish. A standard Mesa table has a perforated metal base inset and metal columns available in Aluminum, Black or White finish.

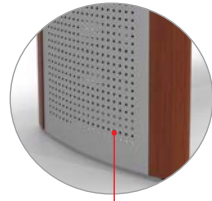

Inset Finishes

Veneer, laminate and metal insets available with additional cost — see upcharge table below.

Metals (Standard):

- MBST** Perforated Aluminum
- MBSB** Perforated Black
- MBSW** Perforated White

Insets with upcharge:

Veneers

- VBME** Match Edge
- VB01** American Cherry
- VB02** Biltmore Cherry
- VB03** Warm Cherry
- VB04** Axiom Cherry
- VB05** Cordovan Cherry
- VB06** Medium Cherry
- VB07** Espresso
- VB08** Deep Cherry
- VB09** Warm Walnut
- VB10** Natural Walnut
- VB11** Ebony on Walnut
- VB12** Natural Maple
- VB13** Fusion Maple
- VB14** Warm Maple
- VB15** Golden Maple
- VB16** Light Mahogany
- VB17** Medium Mahogany
- VB18** Deep Mahogany
- VB19** Natural Oak
- VB20** Medium Oak
- VB21** Wild Cherry
- VBNS** Custom†

Laminates

- LB01** Fusion Maple
- LB02** Wild Cherry
- LB03** Biltmore Cherry
- LB05** Figured Mahogany
- LB09** Black
- LB29** Frosty White
- LB10** Cafelle
- LB11** River Cherry
- LB12** Walnut Heights
- LB13** Licorice Groovz
- LB14** Driftwood
- LB16** Concrete Groovz
- LB18** Aria
- LB19** Silver Frost
- LB20** Shadow Frost
- LB23** Stromboli
- LB25** Fog Grey
- LB26** Pewter Frost
- LB27** Weathered Ash
- LB28** White Ash
- LB04** Slate Grey
- LB06** Pepperdust
- LB30** Beigewood
- LB31** Natural Rift
- LBNS** Custom†

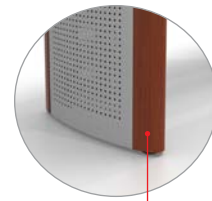

Column Finishes

Veneer columns available with additional cost — see upcharge table below.

Metals (Standard):

- VCST** Aluminum
- VCSB** Black
- VCSW** White

Columns with upcharge:

Veneers

- VC01** American Cherry
- VC02** Biltmore Cherry
- VC03** Warm Cherry
- VC04** Axiom Cherry
- VC05** Cordovan Cherry
- VC06** Medium Cherry
- VC07** Espresso
- VC08** Deep Cherry
- VC09** Warm Walnut
- VC10** Natural Walnut
- VC11** Ebony on Walnut
- VC12** Natural Maple
- VC13** Fusion Maple
- VC14** Warm Maple
- VC15** Golden Maple
- VC16** Light Mahogany
- VC17** Medium Mahogany
- VC18** Deep Mahogany
- VC19** Natural Oak
- VC20** Medium Oak
- VC21** Wild Cherry
- VCNS** Custom†

Base Option Upcharges

Table length	Veneer Inset	Laminate Inset	Veneer columns
8', 9', 10'	\$2,766	\$1,660	\$2,766
11', 12', 14', 16	\$4,150	\$2,490	\$4,150
18', 20', 22'	\$5,532	\$3,319	\$5,532

†For pricing on custom finishes, contact your Friant Sales Consultant.

SELECT BASE OPTION CONTINUED

STANDARD MESA BASE: Matching inset and columns, 3 color choices.



INSET: Perforated metal
 MBST Aluminum
 MBSB Black
 MBSW White

COLUMNS: Metal
 VCST Aluminum
 VCSB Black
 VCSW White

Specify MBST/VCST, MBSB/VCSB, or MBSW/VCSW

ADDITIONAL BASE DESIGNS: Please see upcharge chart



INSET: Laminate
COLUMNS: Aluminum

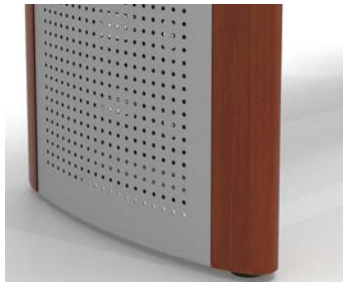

INSET: Perforated Aluminum
COLUMNS: Veneer



INSET:
 Veneer

COLUMNS:
 Aluminum

NUMBER OF DOORS, BASES AND SEAMS

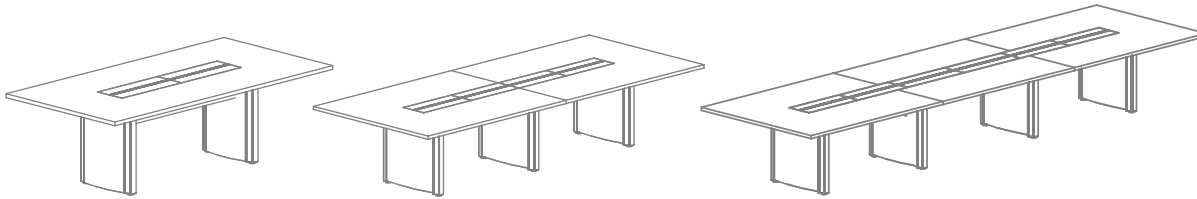
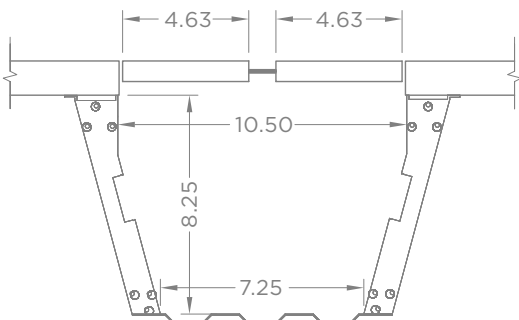

Table Length	8 ft	9 ft	10 ft	11 ft	12 ft	14 ft	16 ft	18 ft	20 ft	22 ft
Doors	4	4	4	4	8	8	8	12	12	12
Bases	2	2	2	3	3	3	3	4	4	4
Seams	0	1	1	1	1	1	2	2	2	2

TROUGH DIMENSIONS



INSIDE BASE CLEARANCE

Base for 48" Wide Top

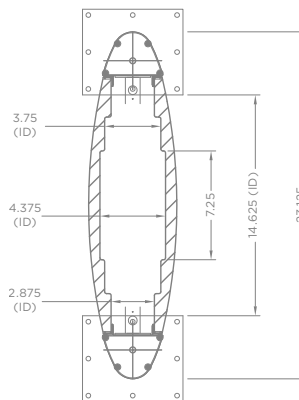

Base for 60" Wide Top

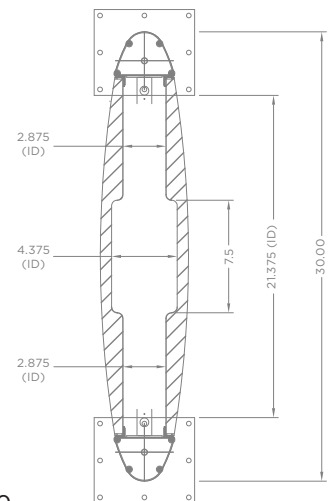

Drawings with base locations for core drilling are available at www.friant.com

TERMS & CONDITIONS

PRICES

All prices are F.O.B. point. We reserve the right to change prices without prior notice.

ORDERING

Purchase Orders should be sent to Friant & Associates, LLC at orders@friant.com, or faxed to (510) 535-6895. If your specifications were created with CAP, GIZA, or Project Matrix please send the worksheet (SP4) with your Purchase Order.

TERMS

Net 30 days from date of invoice with established terms. Invoices are delinquent if not paid (30) days from date of invoice. In the event timely payment is not made, interest will be charged at the rate of 1.5% per month on delinquent accounts. Buyers will also be liable for normal collection costs and attorney fees.

ORDERS

Orders are only accepted by issuance of our formal acknowledgment, and are subject to the terms set forth herein and on our order acknowledgment. It is the responsibility of the buyer to review our acknowledgment for accuracy.

LEAD TIME

Lead times are subject to availability.

ORDER CHANGES AND CANCELLATIONS

Our order confirmation is final and binding. Any order change or cancellation is subject to our ability to conform. For the most up to date information, always review the order change/cancellation policy online. Allowable changes within the posted policy must be made in writing.

RETURNS

No merchandise may be returned without our written consent and shipping instructions, and are subject to a 35% restocking fee. Unauthorized returns will not be accepted and will be returned freight collect. All packages are labeled with contents, and it is the customer's responsibility to check box labels against the packing list for accuracy before opening. If correctly labeled and undamaged product is removed from its original packaging, Friant will not accept its return.

CLAIMS

We are not responsible for damage suffered in transit. Merchandise should be inspected for possible freight damage upon delivery. Claims for damage or shortages should be filed by the consignee with the carrier within 5 days of delivery. You are also protected for "concealed damage" if you file claim with the carrier within 5 days of delivery. All claims against Friant for defects, errors or shortages must be made by Buyer in writing within 10 days after delivery. Failure to make such a claim shall constitute full acceptance. All claims must be pre-approved and with a P.O. issued to Friant before reimbursement and/or reinstallation will be granted.

SHIPPING

Friant generally palletizes, boxes and/or shrink wraps its products. If Buyer requests additional packaging or special shipping, extra charges will apply. Buyer obtains title to products and assumes the risk of loss for them upon shipment from Friant's plant.

PARTIAL SHIPMENTS

We will make every attempt to ship orders complete and on schedule. However, we reserve the right to make partial shipments as merchandise is ready. Invoices covering these partial shipments are to be paid as they become due.

SHIPPING AND PREPAID FREIGHT

Unless otherwise instructed, we reserve the option to ship by what is, in our opinion, the best possible way. Upon request, we will prepay and add freight for accounts with established credit. Please see our web site for estimated freight times.

DELIVERY

We are not liable for delay or failure of delivery due to strikes and/or differences with workmen, war, riot, fire, compliance with government regulations, acts of nature, failure or delays of sources of supply, or any other causes beyond our control.

STORAGE

If buyer cannot accept delivery when merchandise is ready, we reserve the right to transfer goods to storage. Costs of transfer and storage will be charged to the buyer's account, and we will deem such transfer as constituting shipment for all purposes, including invoicing, as of the date the transfer is made.

CONSTRUCTION - SPECIFICATIONS

All items are produced to price list specifications unless otherwise advised. All dimensions shown are approximate. Manufacturer reserves the right to make modifications and/or improvements without prior notice.

COMPLIANCE WITH LAW

Purchaser is solely responsible for compliance with all applicable Federal, State and Local laws, ordinances, regulations, rules and standards relating to the installation, maintenance, use and operation of products.

TERMS & CONDITIONS

CALIFORNIA PROP 65 WARNING

Products in this catalog can expose you to chemicals including wood dust, which is known to the State of California to cause cancer or birth defects or other reproductive harm. For more information go to <https://www.p65warnings.ca.gov/products/furniture-products>."

CARB

Friant products are CARB 93120 compliant for formaldehyde (phase 2)

TSCA TITLE VI

Friant products are TSCA Title VI Compliant

MAS

Accredited Compliance Designation - ANSI/BIFMA x7.1 & e3-2014 7.6.1, 7.6.2, 7.6.3

California Dept. Of Public Health Standard Method v1.2

Conforms With: LEED v4

Criteria of MAS Certified Green® Program

CARE AND MAINTENANCE

Friant & Associates' finish provides excellent stain and mar resistance. Care should be exercised when cleaning. The following precautions will help keep the product looking new:

- Dust all surfaces on a regular basis with a soft damp cloth. Do not use spray polishes – especially those containing silicone.
- Lift all objects from the surface when moving – never drag objects across the surface.
- Metal objects should be kept from contacting the surface.

TERMS & CONDITIONS

LUNE AND SCOPE RIGHTS AND WARRANTIES – LIMITED LIFETIME WARRANTY

This warranty is given to the initial purchaser and is valid from the date of purchase, for as long as the initial purchaser owns the product. This warranty covers defects in material and craftsmanship found during normal usage of the product during the warranty period. Normal usage is defined by 8 hour shifts in the product's intended application and in an indoor environment that conforms to the ANSI/ASHRAE Standard 55: Thermal Environmental Conditions for Human Occupancy (relating to air temperature, mean radiant temperature, air velocity, clothing insulation, metabolic rate, and humidity). Friant's warranty does not cover usage other than normal usage as defined in the previous sentence. If the product is defective, and if written notice of the defect is given to Friant & Associates within the applicable warranty period, Friant & Associates, at its option, will either repair or replace the defective product with a comparable component or product. This warranty applies to all products except as noted below.

MESA PRODUCT WARRANTY - 3 YEARS

This warranty is given to the initial purchaser and is valid from the date of purchase, for 3 years. This warranty covers defects in material and craftsmanship found during normal usage of the product during the warranty period. Normal usage is defined by 8 hour shifts in the product's intended application and in an indoor environment that conforms to the ANSI/ASHRAE Standard 55: Thermal Environmental Conditions for Human Occupancy (relating to air temperature, mean radiant temperature, air velocity, clothing insulation, metabolic rate, and humidity). Friant's warranty does not cover usage other than normal usage as defined in the previous sentence. If the product is defective, and if written notice of the defect is given to Friant & Associates within the applicable warranty period, Friant & Associates, at its option, will either repair or replace the defective product with a comparable component or product. This warranty applies to all products except as noted below.

WARRANTY EXCEPTIONS:

- Natural variations in wood grain, figure or the presence of character marks
- Matching of colors, grains, textures
- Changes in surface finishes due to aging or exposure to light
- Damage, marking or staining of surfaces due to contact with rubber or similar compounds
- Damage from sharp objects or imprinting from writing instruments, computer equipment or prolonged exposure to fluids or sun
- Checking or delaminating due to changes in temperature or improper care or storage
- Damage caused by misuse or improper care

High wear parts, such as wood veneer, fabrics, laminates, and other covering material/finishes, foam, glides, etc. are warranted for one (1) year. This warranty does not apply to damage caused by a carrier, alteration to the product not expressly authorized by Friant & Associates, nor to product considered to be of a consumable nature such as bulbs, light ballasts, etc. It also does not apply to "Customer's Own Material" (i.e. material specified by the customer that is not a standard Friant & Associates offering) used in the manufacture of Friant & Associates products.

Friant & Associates does not guarantee the matching of colors, grain or texture, except to within commercially acceptable standards. This includes normal variations between dye lots (fabrics).

A product will not be considered defective, and Friant & Associates will not be obligated to replace it, if it is not installed in a proper manner (i.e., product not leveled, not secured properly, etc.) or if it is not used in a manner and/or in an environment that constitutes normal usage, as defined above.

Except as noted above, Friant & Associates makes no express or implied warranties as to any product, and in particular makes no warranty of fitness for any particular use. At Friant & Associates' option, product repair and/or replacement are the customer's exclusive remedy for any and all product defects.

Friant & Associates shall not be liable for consequential, economic or incidental damages arising from any product defect.